



Meaningful Innovation.

WEEE Number: 80133970

INSTRUCTION MANUAL

LED FLOOD LIGHT



TECHNICAL DATA

MODEL	SKU	WATTS	LUMENS	BEAM ANGLE	DF	CRI	INPUT POWER	OPERATION TEMPERATURE	DIMENSION (LxWxH)	N.W. (KGS)	MAX MOUNTING HEIGHT	PROJECTED AREA(mm ²)	WIRE LENGTH
VT-44010	9898,9899,10010 10011,10012,10013	10W	735LM	115°	>0.9	>70	AC220-240V 50Hz	-20°C to +45°C	104x21x92mm	0.16	<5M	9568	0.15M
VT-44020	10014,10015,10016 10017,10018,10019	20W	1620LM	115°	>0.9	>70	AC220-240V 50Hz	-20°C to +45°C	126.5x28x114mm	0.24	<5M	14421	0.15M
VT-44030	10020,10021,10022 10023,10024,10025	30W	2505LM	115°	>0.9	>70	AC220-240V 50Hz	-20°C to +45°C	164x29x139mm	0.35	<5M	22796	0.15M
VT-44050	10026	50W	4270LM	115°	>0.9	>70	AC220-240V 50Hz	-20°C to +45°C	183x29x169mm	0.48	<5M	30927	0.15M
VT-44100	10348	100W	8700LM	115°	>0.9	>70	AC220-240V 50Hz	-20°C to +45°C	183x29x169mm	0.97	<5M	55118	1M
VT-44200	10027,10028, 10029,10030	200W	17540LM	115°	>0.9	>70	AC220-240V 50Hz	-20°C to +45°C	405x36x326mm	2.29	<5M	132030	1M
VT-44300	10031,10032 10033,10034	300W	26390LM	115°	>0.9	>70	AC220-240V 50Hz	-20°C to +45°C	496x49x445mm	4.28	<5M	220720	1M

*This product contains a light source of energy efficiency class<F>,where <F> shall be replaced by the energy class of the contained light source.

INTRODUCTION & WARRANTY

Thank you for selecting and buying V-TAC product. V-TAC will serve you the best. Please read these instructions carefully before starting the installing and keep this manual handy for future reference. If you have any another query, please contact our dealer or local vendor from whom you have purchased the product. They are trained and ready to serve you at the best. The warranty is valid for 5 years from the date of purchase. The warranty does not apply to damage caused by incorrect installation or abnormal wear and tear. The company gives no warranty against damage to any surface due to incorrect removal and installation of the product. The products are suitable for 10-12 Hours Daily operation. Usage of product for 24 Hours a day would void the warranty. This product is warranted for manufacturing defects only.



IP65
RATING

05 YEAR
WARRANTY*

SAMSUNG
LED
Illuminated

PRO
SERIES

WARNING

- Please make sure to turn off the power before starting the installation.
- Installation must be performed by a qualified electrician.
- The light source contained in this luminaire shall only be replaced by the manufacturer or his service agent or a similar qualified person.
- If the external flexible cable or cord of this luminaire is damaged, it shall be exclusively replaced by the manufacturer or his service agent or a similar qualified person in order to avoid a hazard.
- Terminal block not included.
- Proper grounding should be ensured throughout the installation.
- For outdoor use.
- Replace any cracked protective shield. 
- Minimum distance from lighted objects 1m. 

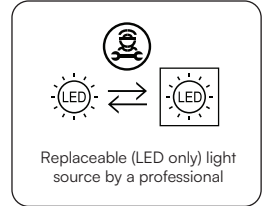

NOTE: To reduce the risk of strangulation the flexible wiring connected to this luminaire shall be effectively fixed to the wall if the wiring is within arm's reach.



This marking indicates that this product should not be disposed of with other household wastes.



Caution, risk of electric shock.



MULTI-LANGUAGE MANUAL QR CODE

Please scan the QR code to access the manual in multiple languages.

INSTALLATION DIAGRAM

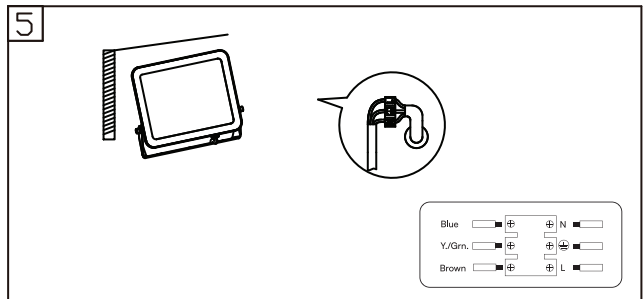
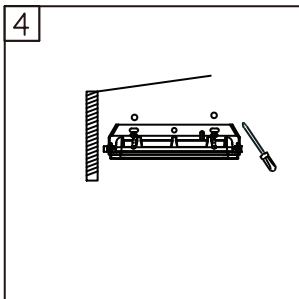
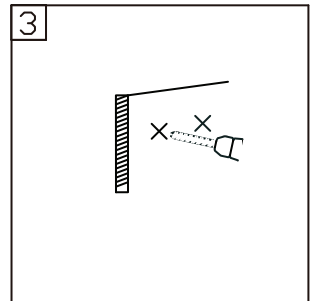
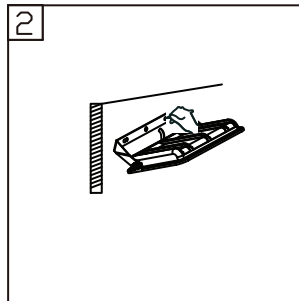
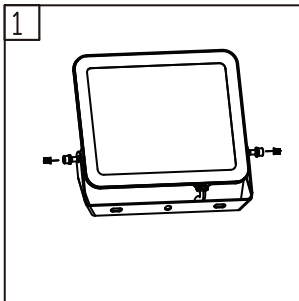

INSTALLATION INSTRUCTION

- DO NOT USE IN AREAS WITH LIMITED VENTILATION OR OUTSIDE THE RATED AMBIENT TEMPERATURE RANGE. *CONNECT WITH WATERPROOF CABLE HOUSE ONLY. *ENSURE ELECTRICITY IS SWITCH OFF BEFORE INSTALLATION.
- Please do not mount to a surface that is prone to vibrations.*
- Remove the screw and the bracket afterward. (Figure 1) Before drilling, mark the hole position for fixing the bracket onto the wall (Screw not supplied). (Figure 2)
- Screw the retaining bracket to the wall with a suitable quantity of screws. (Figure 3)
- Mount the bracket back to the fixture. Adjust the floodlight according to the desired position. Tighten the screw. (Figure 4) Connect your main cable (H05RN-F3G1.0mm2 Recommended) with the input lead of our product through the waterproof junction box. Note, the line (-) of the lead. (Figure 5) (Need to use the junction box of IP65 or above, ensure to tighten the waterproof screw) Switch on the power to make sure if the product is working.

DISMANTLING INSTRUCTIONS

(For Market surveillance team only)

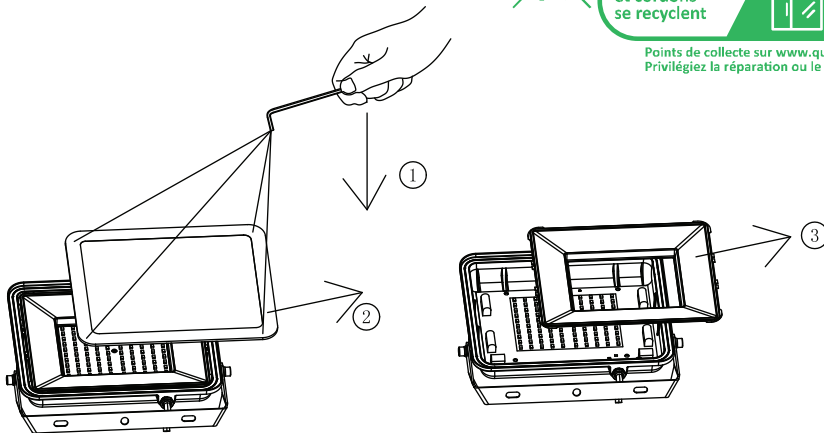

Note: Light source removal will void the warranty



IN CASE OF ANY QUERY/ISSUE WITH THE PRODUCT, PLEASE REACH OUT TO US AT: SUPPORT@V-TAC.EU
FOR MORE PRODUCTS RANGE, INQUIRY PLEASE CONTACT OUR DISTRIBUTOR OR NEAREST DEALERS.
V-TAC EUROPE LTD. BULGARIA, PLOVDIV 4000, BUL.L.KARAVELOW 9B

РЪКОВОДСТВО ЗА УПОТРЕБА ДОВЕДЕ НАВОДНЕНИЕ СВЕТЛИНА



ТЕХНИЧЕСКИ ДАННИ

MODEL	SKU	WATTS	LUMENS	BEAM ANGLE	DF	CRI	INPUT POWER	OPERATION TEMPERATURE	DIMENSION (LxWxH)	N.W. (KGS)	МАКСИМАЛНА МОНТАЖНА ВИСОЧИНА	ПРОГНОЗИРАНО ПЛОЩ (mm ²)	ДЪЛЖИНА НА ПРОВОДНИКА
VT-44010	9898,9899,10010 10011,10012,10013	10W	735LM	115°	>0.9	>70	AC220-240V 50Hz	-20°C to +45°C	104x21x92mm	0.16	<5M	9568	0.15M
VT-44020	10014,10015,10016 10017,10018,10019	20W	1620LM	115°	>0.9	>70	AC220-240V 50Hz	-20°C to +45°C	126,5x28x114 мм	0.24	<5M	14421	0.15M
VT-44030	10020,10021,10022 10023,10024,10025	30W	2505LM	115°	>0.9	>70	AC220-240V 50Hz	-20°C to +45°C	164x29x139 мм	0.35	<5M	22796	0.15M
VT-44050	10026	50W	4270LM	115°	>0.9	>70	AC220-240V 50Hz	-20°C to +45°C	183x29x169 мм	0.48	<5M	30927	0.15M
VT-44100	10348	100W	8700LM	115°	>0.9	>70	AC220-240V 50Hz	-20°C to +45°C	183x29x169 мм	0.97	<5M	55118	1M
VT-44200	10027,10028, 10029,10030	200W	17540LM	115°	>0.9	>70	AC220-240V 50Hz	-20°C to +45°C	405x36x326 мм	2.29	<5M	132030	1M
VT-44300	10031,10032 10033,10034	300W	26390LM	115°	>0.9	>70	AC220-240V 50Hz	-20°C to +45°C	496x49x445 мм	4.28	<5M	220720	1M

*Този продукт съдържа светлинен източник с клас на енергийна ефективност <F>, където <F> се заменя с енергийния клас на съдържащия се светлинен източник.

ВЪВЕДЕНИЕ И ГАРАНЦИЯ

Благодарим ви, че избрахте и закупихте продукт на V-TAC. V-TAC ще ви служи по най-добрия начин. Моля, прочетете внимателно тези инструкции, преди да започнете инсталационното, и запазете това ръководство под ръка за бъдещи справки. Ако имате други въпроси, моля, свържете се с нашия дилър или с местния продавач, от когото сте закупили продукта. Те са обучени и са готови да ви обслужват по най-добрия начин. Гаранцията е валидна за срок от 5 години от датата на закупуване. Гаранцията не важи за повреди, причинени от неправилен монтаж или необичайно износване. Фирмата не дава гаранция за повреди на повърхности, дължащи се на неправилно демонтиране и инсталиране на продукта. Продуктите са подходящи за 10-12-часова ежедневна работа. Използване на продукта за 24 часа в денонощието би довело до анулиране на гаранцията. Този продукт има гаранция само за производствени дефекти.



**IP65
RATING**

**05
YEAR
WARRANTY***

**SAMSUNG
LED
Illuminated**

**PRO
SERIES**

ПРЕДУПРЕЖДЕНИЕ

- Моля, уверете се, че сте изключили захранването, преди да започнете монтажа.
- Монтажът трябва да се извърши от квалифициран електротехник.
- Източникът на светлина, съдържащ се в това осветително тяло, може да бъде подменян само от производителя, неговия сервизен агент или от подобно квалифицирано лице.
- Ако външният гъвкав кабел или шнур на това осветително тяло е повреден, той трябва да бъде подменен изключително от производителя, неговия сервизен агент или подобно квалифицирано лице, за да се избегне опасност.
- Клемният блок не е включен.
- По време на инсталацията трябва да се осигури правилно заземяване.
- За използване на открито.
- Заменете всеки спукан защитен щит. 
- Минимално разстояние от осветени обекти 1 м. 



ЗАБЕЛЕЖКА: За да се намали рискът от задушаване, гъвкавото окабеляване, свързано с това осветително тяло, трябва да бъде ефективно закрепено към стената, ако окабеляването е на една ръка разстояние.



Тази маркировка показва, че този продукт не трябва да се изхвърля заедно с други битови отпадъци.



Внимание, риск от токов удар.

МОНТАЖНА СХЕМА

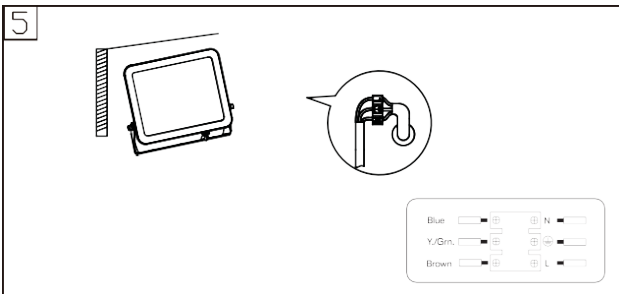
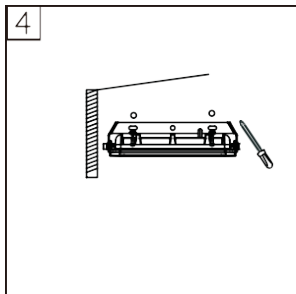
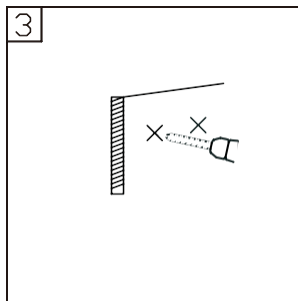
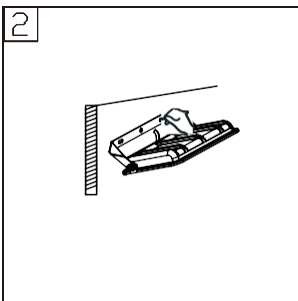
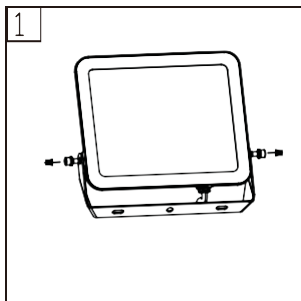

ИНСТРУКЦИЯ ЗА МОНТАЖ

- НЕ ИЗПОЛЗВАЙТЕ В ПОМЕЩЕНИЯ С ОГРАНИЧЕНА ВЕНТИЛАЦИЯ ИЛИ ИЗВЪН НОМИНАЛНИЯ ТЕМПЕРАТУРЕН ДИАПАЗОН НА ОКОЛНАТА СРЕДА. *СВЪРЗВАЙТЕ САМО С ВОДОУСТОЙЧИВА КАБЕЛНА КЪЩА. *ПРЕДИ МОНТАЖА СЕ УВЕРЕТЕ, ЧЕ ЕЛЕКТРИЧЕСТВОТО Е ИЗКЛЮЧЕНО.
- Моля, не монтирайте към повърхност, която е склонна към вибрации.*
- След това отстранете винта и скобата. (Фигура 1) Преди да пробие, маркирайте позицията на отвора за закрепване на скобата към стената (Винтът не е в комплекта). (Фигура 2)
- Завийте фиксиращата скоба към стената с подходящо количество винтове. (Фигура 3)
- Монтирайте скобата обратно към приспособлението. Настройте прожектора в желаната позиция. Затегнете винта. (Фигура 4) Свържете основния си кабел (препоръчва се H05RN-F3G1,0 mm²) с входния проводник на нашия продукт през водоустойчивата разклонителна кутия. Обърнете внимание на линията (-) на кабела. (Фигура 5) (Необходимо е да използвате разклонителна кутия с клас IP65 или по-висок, уверете се, че сте затегнали водоустойчивия винт) Включете захранването, за да се уверите, че продуктът работи.

ИНСТРУКЦИИ ЗА РАЗГЛОБЯВАНЕ (Само за екипа за наблюдение на пазара)

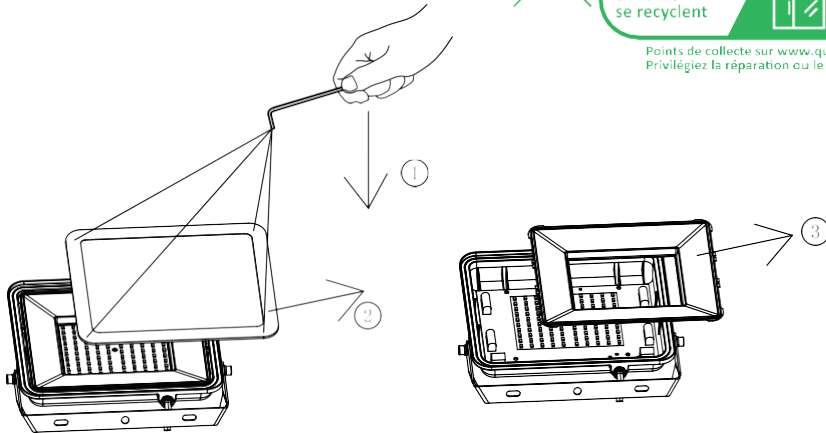

Забележка: Отстраняването на светлинния източник води до анулиране на гаранцията.



RoHS



UK
CA



В СЛУЧАЙ НА ЗАПИТВАНЕ/ПРОБЛЕМ С ПРОДУКТА, МОЛЯ, СВЪРЖЕТЕ СЕ С НАС НА: SUPPORT@V-TAC.EU ЗА ПОВЕЧЕ ПРОДУКТОВА ГАМА, ЗАПИТВАНЕ, МОЛЯ, СВЪРЖЕТЕ СЕ С НАШИЯ ДИСТРИБУТОР ИЛИ НАЙ-БЛИЗКИТЕ ДИЛЪРИ.
V-TAC EUROPE LTD. БЪЛГАРИЯ, ПЛОВДИВ 4000, BUL.L.KARAELOW 9B

V-TAC

Meaningful Innovation.

WEEE Number: 80133970

UPUTE ZA UPORABU LED REFLAKT



TEHNIČKI PODACI

MODEL	SKU	WATTS	LUMENS	Kut svjetlosti og snopa	DF	CRI	Ulazni napon	Radna temperatura	Dimenzija (DxŠxV)	N.W. (KGS)	Maksimalna visina montaže	Projektirano područje (mm ²)	DULJINA ŽICE
VT-44010	9898,9899,10010 10011,10012,10013	10W	735LM	115°	>0.9	>70	AC220-240V 50Hz	-20°C to +45°C	104x21x92mm	0.16	<5M	9568	0.15M
VT-44020	10014,10015,10016 10017,10018,10019	20W	1620LM	115°	>0.9	>70	AC220-240V 50Hz	-20°C to +45°C	126.5x28x114mm	0.24	<5M	14421	0.15M
VT-44030	10020,10021,10022 10023,10024,10025	30W	2505LM	115°	>0.9	>70	AC220-240V 50Hz	-20°C to +45°C	164x29x139mm	0.35	<5M	22796	0.15M
VT-44050	10026	50W	4270LM	115°	>0.9	>70	AC220-240V 50Hz	-20°C to +45°C	183x29x169mm	0.48	<5M	30927	0.15M
VT-44100	10348	100W	8700LM	115°	>0.9	>70	AC220-240V 50Hz	-20°C to +45°C	183x29x169mm	0.97	<5M	55118	1M
VT-44200	10027,10028, 10029,10030	200W	17540LM	115°	>0.9	>70	AC220-240V 50Hz	-20°C to +45°C	405x36x326mm	2.29	<5M	132030	1M
VT-44300	10031,10032 10033,10034	300W	26390LM	115°	>0.9	>70	AC220-240V 50Hz	-20°C to +45°C	496x49x445mm	4.28	<5M	220720	1M

*Ovaj proizvod sadrži izvor svjetlosti klase energetske učinkovitosti <F>, gdje <F> treba zamijeniti energetskom klasom sadržanog izvora svjetlosti.

UVOD & JAMSTVO

Hvala što ste odabrali i kupili V-TAC proizvod. V-TAC će vam poslužiti najbolje. Pažljivo pročitajte ove upute prije početka instalacije i držite ovaj priručnik pri ruci za buduće potrebe. Ako imate bilo kakvih dodatnih pitanja, obratite se našem trgovcu ili lokalnom prodavaču od kojeg ste kupili proizvod. Oni su obučeni i spremni poslužiti vas na najbolji način. Jamstvo vrijedi 5 godina od datuma kupnje. Jamstvo se ne odnosi na oštećenja uzrokovana neispravnom ugradnjom ili nenormalnim habanjem. Tvrtka ne daje jamstvo protiv oštećenja bilo koje površine uslijed nepravilnog uklanjanja i postavljanja proizvoda. Proizvodi su prikladni za 10-12 sati dnevnog rada. Korištenje proizvoda 24 sata dnevno poništilo bi jamstvo. Ovaj proizvod ima jamstvo samo za greške nastale u proizvodnji.



**IP65
RATING**

**05
YEAR
WARRANTY***

**SAMSUNG
LED
Illuminated**

**PRO
SERIES**

UPOZORENJE

- Provjerite jeste li isključili napajanje prije početka instalacije.
- Instalaciju mora izvesti kvalificirani električar.
- Izvor svjetlosti koji se nalazi u ovoj svjetiljci smije zamijeniti samo proizvođač ili njegov serviser ili slična kvalificirana osoba.
- Ako je vanjski savitljivi kabel ili kabel ove svjetiljke oštećen, zamijenit će ga isključivo proizvođač ili njegov serviser ili slična kvalificirana osoba kako bi se izbjegla opasnost.
- Terminalni blok nije uključen.
- Ispravno uzemljenje mora biti osigurano tijekom cijele instalacije.
- Za vanjsku upotrebu.
- Zamijenite svaki napuknuti zaštitni štít. 
- Minimalna udaljenost od osvijetljenih objekata 4 m . 



NAPOMENA: Kako bi se smanjio rizik od davljenja, fleksibilno ožičenje spojeno na ovu svjetiljku mora biti učinkovito pričvršćeno na zid ako je ožičenje nadohvat ruke.



Ova oznaka označava da se ovaj proizvod ne smije odlagati s ostalim kućnim otpadom.



Oprez, opasnost od strujnog udara.

DIJAGRAM UGRADNJE

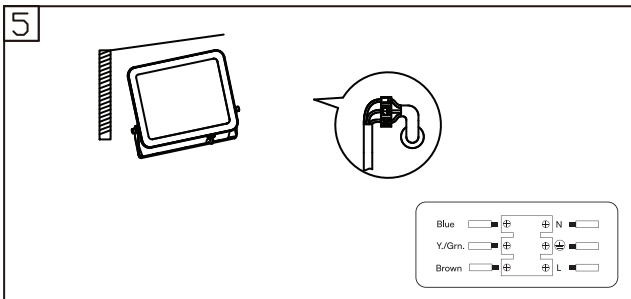
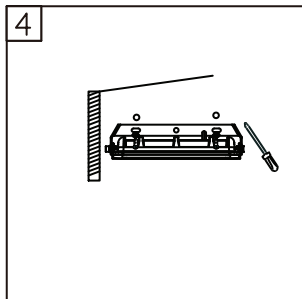
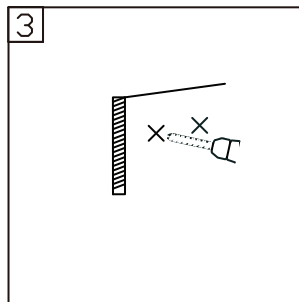
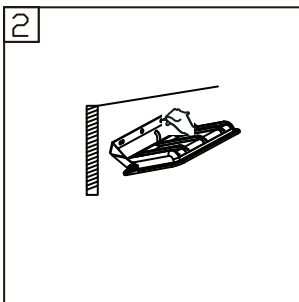
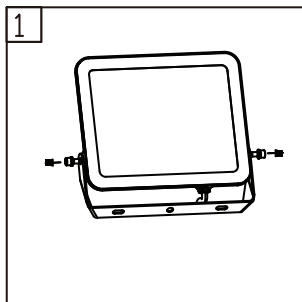

UPUTE ZA MONTAŽU

- NE KORISTITE U PODRUČJIMA S OGRANIČENOM VENTILACIJOM ILI IZVAN NAZIVNOG RASPONA AMBIJENTNE TEMPERATURE. *POVEZIVANJE SAMO SA VODOOTPORNOM KUĆOM ZA KABEL. *PROVJERITE DA JE STRUJA ISKLJUČENA PRIJE INSTALACIJE.
- Nemojte postavljati na površinu koja je sklona vibracijama.*
- Nakon toga uklonite vijak i nosač. (Slika 1) Prije bušenja označite položaj rupe za pričvršćivanje nosača na zid (vijci nisu isporučeni). (Slika 2)
- Učvrstni nosač pričvrstite na zid odgovarajućom količinom vijaka. (Slika 3)
- Montirajte nosač natrag na učvršćenje. Podesite reflektor prema željenom položaju. Zategnite vijak. (Slika 4) Povežite svoj glavni kabel (preporučuje se HO5RN-F3G1,0 mm²) s ulaznim kabelom našeg proizvoda kroz vodootpornu razvodnu kutiju. Napomena, linija (-) odvoda. (Slika 5) (Potrebno je koristiti razvodnu kutiju IP65 ili više, pričvrstiti vodootporni vijak) Uključite napajanje kako biste bili sigurni da proizvod radi.

UPUTE ZA DEMONTAŽU

(Samo za tim za nadzor tržišta)

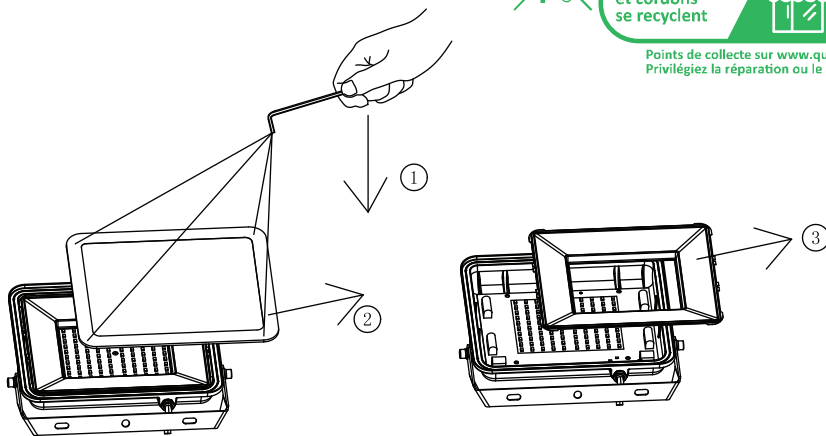

Napomena: Uklanjanje izvora svjetla poništiti će jamstvo



Points de collecte sur www.quefairedemesdechets.fr
Privilégiez la réparation ou le don de votre appareil !



U SLUČAJU BILO KAKVOG UPITA/PROBLEMA S PROIZVODOM, OBRATITE NAM SE NA: SUPPORT@V-TAC.EU ZA VIŠE PROIZVODA, UPIT MOLIMO DA KONTAKTIRATE NAŠEG DISTRIBUTERA ILI NAJBLIŽEG TRGOVCA. V-TAC EUROPE LTD. BUGARSKA, PLOVDIV 4000, BUL.L.KARAVELOW 9B

NÁVOD K POUŽITÍ

LED SVĚTLO



TECHNICKÉ ÚDAJE

MODEL	SKU	WATTS	LUMENS	BEAM ANGLE	DF	CRI	INPUT POWER	OPERATION TEMPERATURE	DIMENSION (LxWxH)	N.W. (KGS)	MAXIMÁLNÍ MONTÁŽNÍ VÝŠKA	PROJEKTOVANÉ Plocha (mm ²)	DĚLKA VODIČE
VT-44010	9898,9899,10010 10011,10012,10013	10W	735LM	115°	>0.9	>70	AC220-240V 50Hz	-20°C to +45°C	104x21x92mm	0.16	<5M	9568	0.15M
VT-44020	10014,10015,10016 10017,10018,10019	20W	1620LM	115°	>0.9	>70	AC220-240V 50Hz	-20°C to +45°C	126,5x28x114 mm	0.24	<5M	14421	0.15M
VT-44030	10020,10021,10022 10023,10024,10025	30W	2505LM	115°	>0.9	>70	AC220-240V 50Hz	-20°C to +45°C	164x29x139 mm	0.35	<5M	22796	0.15M
VT-44050	10026	50W	4270LM	115°	>0.9	>70	AC220-240V 50Hz	-20°C to +45°C	183x29x169 mm	0.48	<5M	30927	0.15M
VT-44100	10348	100W	8700LM	115°	>0.9	>70	AC220-240V 50Hz	-20°C to +45°C	183x29x169 mm	0.97	<5M	55118	1M
VT-44200	10027,10028, 10029,10030	200W	17540LM	115°	>0.9	>70	AC220-240V 50Hz	-20°C to +45°C	405x36x326mm	2.29	<5M	132030	1M
VT-44300	10031,10032 10033,10034	300W	26390LM	115°	>0.9	>70	AC220-240V 50Hz	-20°C to +45°C	496x49x445mm	4.28	<5M	220720	1M

*Tento výrobek obsahuje světelný zdroj třídy energetické účinnosti<F>, kde <F> je nahrazeno energetickou třídou obsaženého světelného zdroje.

ÚVOD A ZÁRUKA

Děkujeme, že jste si vybrali a zakoupili produkt V-TAC. V-TAC vám bude sloužit co nejlépe. Před zahájením instalace si pozorně přečtete tento návod a uschovejte jej pro budoucí použití. V případě dalších dotazů se obraťte na našeho prodejce nebo místního prodejce, od kterého jste výrobek zakoupili. Jsou vyškoleni a připraveni vám co nejlépe posloužit. Záruka je platná po dobu 5 let od data zakoupení. Záruka se nevztahuje na poškození způsobené nesprávnou instalací nebo abnormálním opotřebením. Společnost neposkytuje záruku na poškození jakéhokoli povrchu v důsledku nesprávné demontáže a instalace výrobku. Výrobky jsou vhodné pro 10-12 hodin denního provozu. Použití výrobku po 24 hodin denně by znamenalo ztrátu záruky. Na tento výrobek se vztahuje záruka pouze na výrobní vadu.



**IP65
RATING**

**05
YEAR
WARRANTY***

**SAMSUNG
LED
Illuminated**

**PRO
SERIES**

VAROVÁNÍ

- Před zahájením instalace nezapomeňte vypnout napájení.
- Instalaci musí provést kvalifikovaný elektrikář.
- Světelný zdroj obsažený v tomto svítidle smí vyměnit pouze výrobce nebo jeho servisní zástupce nebo podobně kvalifikovaná osoba.
- Pokud dojde k poškození vnějšího ohebného kabelu nebo šňůry tohoto svítidla, musí být vyměněn výhradně výrobcem nebo jeho servisním zástupcem nebo podobně kvalifikovanou osobou, aby se předešlo nebezpečí.
- Svorkovnice není součástí dodávky.
- Správné uzemnění by mělo být zajištěno v celé instalaci.
- Pro venkovní použití.
- Vyměňte prasklý ochranný štít. 
- Minimální vzdálenost od osvětlených objektů 1 m. 

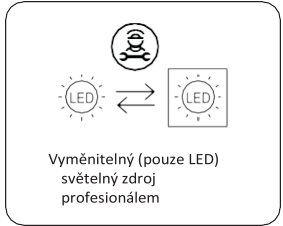

POZNÁMKA: Aby se snížilo riziko uškrcení, musí být ohebná kabeláž připojená k tomuto svítidlu účinně připevněna ke stěně, pokud je kabeláž v dosahu rukou.



Toto označení znamená, že tento výrobek by neměl být likvidován společně s ostatním domovním odpadem.



Pozor, nebezpečí úrazu elektrickým proudem.

INSTALAČNÍ SCHÉMA

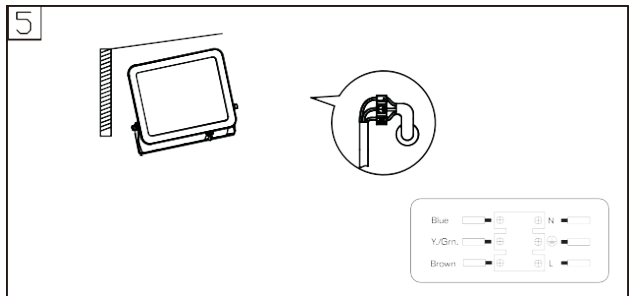
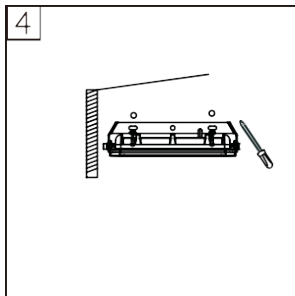
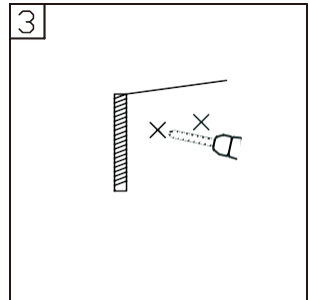
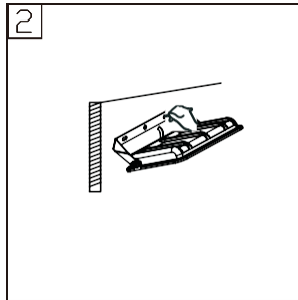
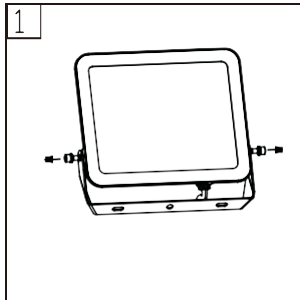

NÁVOD K INSTALACI

- NEPOUŽÍVEJTE V PROSTORÁCH S OMEZENÝM VĚTRÁNÍM NEBO MIMO JMENOVITÝ ROZSAH OKOLNÍ TEPLoty. *PŘIPOJUJTE POUZE POMOCÍ VODOTĚSNÉHO KABELOVÉHO DOMKU. *PŘED INSTALACÍ SE UJISTĚTE, ŽE JE VYPNUTÁ ELEKTRÍNA.
- Nemontujte na povrch, který je náchylný k vibracím.*
- Poté šroub a držák odstraňte. (Obrázek 1) Před vrtáním si označte polohu otvoru pro upevnění držáku na stěnu (šroub není součástí dodávky). (Obrázek 2)
- Přišroubujte držák ke stěně vhodným počtem šroubů. (Obrázek 3)
- Připevněte držák zpět k upevňovacímu prvku. Nastavte reflektor do požadované polohy. Utáhněte šroub. (Obrázek 4) Propojte hlavní kabel (doporučujeme H05RN-F3G1,0 mm2) se vstupním kabelem našeho výrobku přes vodotěsnou propojovací krabici. Všimněte si, že vedení (-) přívodu. (Obrázek 5) (Je třeba použít rozvodnou krabici s krytím IP65 nebo vyšším, ujistěte se, že je vodotěsný šroub dotažen) Zapněte napájení, abyste se ujistili, zda výrobek funguje.

NÁVOD NA DEMONTÁŽ

(Pouze pro tým pro dohled nad trhem)

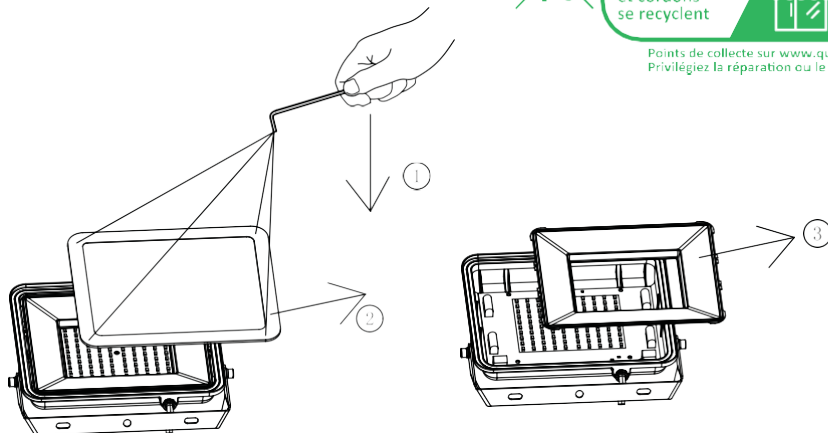

Poznámka: Odstraněním světelného zdroje zaniká záruka.



Points de collecte sur www.quefairedemesdechets.fr
Privilégiez la réparation ou le don de votre appareil !



V PŘÍPADĚ JAKÉHOKOLI DOTAZU NEBO PROBLÉMU S PRODUKTEM SE NA NÁS OBRÁTEJTE NA: PRO VÍCE INFORMACÍ O SORTIMENTU SE PROSÍM OBRÁTEJTE NA NAŠEHO DISTRIBUTORA NEBO NEJBLIŽŠÍ PRODEJCE.
V-TAC EUROPE LTD. BULHARSKO, PLOVDIV 4000, BUL.L.KARAVELOW 9B

V-TAC

Meaningful Innovation.

WEEE Number: 80133970

MANUEL D'INSTRUCTIONS

LUMIÈRE D'INONDATION LED



DONNÉES TECHNIQUES

MODÈLE	SKU	WATTS	LUMENS	Angle du faisceau	DF	CRI	Tension d'entrée	Température de fonctionnement	DIMENSION (LxWxH)	Poids net (KGS)	Hauteur de montage maximale	Surface projetée (mm ²)	Longueur du fil
VT-44010	9898,9899,10010 10011,10012,10013	10W	735LM	115°	>0.9	>70	AC220-240V 50Hz	-20°C to +45°C	104x21x92mm	0.16	<5M	9568	0.15M
VT-44020	10014,10015,10016 10017,10018,10019	20W	1620LM	115°	>0.9	>70	AC220-240V 50Hz	-20°C to +45°C	126.5x28x114mm	0.24	<5M	14421	0.15M
VT-44030	10020,10021,10022 10023,10024,10025	30W	2505LM	115°	>0.9	>70	AC220-240V 50Hz	-20°C to +45°C	164x29x139mm	0.35	<5M	22796	0.15M
VT-44050	10026	50W	4270LM	115°	>0.9	>70	AC220-240V 50Hz	-20°C to +45°C	183x29x169mm	0.48	<5M	30927	0.15M
VT-44100	10348	100W	8700LM	115°	>0.9	>70	AC220-240V 50Hz	-20°C to +45°C	183x29x169mm	0.97	<5M	55118	1M
VT-44200	10027,10028, 10029,10030	200W	17540LM	115°	>0.9	>70	AC220-240V 50Hz	-20°C to +45°C	405x36x326mm	2.29	<5M	132030	1M
VT-44300	10031,10032 10033,10034	300W	26390LM	115°	>0.9	>70	AC220-240V 50Hz	-20°C to +45°C	496x49x445mm	4.28	<5M	220720	1M

*Ce produit contient une source lumineuse de classe d'efficacité énergétique<F>, où <F> est remplacé par la classe énergétique de la source lumineuse contenue.

INTRODUCTION ET GARANTIE

Merci d'avoir choisi et acheté un produit V-TAC. V-TAC vous servira au mieux. Veuillez lire attentivement ces instructions avant de commencer l'installation et conservez ce manuel à portée de main pour pouvoir vous y référer ultérieurement. Si vous avez d'autres questions, veuillez contacter notre revendeur ou le vendeur local auprès duquel vous avez acheté le produit. Ils sont formés et prêts à vous servir au mieux. La garantie est valable pendant 5 ans à compter de la date d'achat. La garantie ne s'applique pas aux dommages causés par une installation incorrecte ou une usure anormale. L'entreprise ne garantit pas les dommages causés à toute surface par un démontage et une installation incorrects du produit. Les produits conviennent pour un fonctionnement quotidien de 10 à 12 heures. L'utilisation du produit pendant 24 heures par jour annule la garantie. Ce produit est garanti pour les défauts de fabrication uniquement.



**IP65
RATING**

**05
YEAR
WARRANTY***

**SAMSUNG
LED
illuminated**

**PRO
SERIES**

Avertissement

- Veillez à couper le courant avant de commencer l'installation.
- L'installation doit être effectuée par un électricien qualifié.
- La source lumineuse contenue dans ce luminaire ne doit être remplacée que par le fabricant, son agent de service ou une personne qualifiée similaire.
- Si le câble ou le cordon flexible externe de ce luminaire est endommagé, il doit être remplacé exclusivement par le fabricant ou son agent de service ou une personne qualifiée similaire afin d'éviter tout danger.
- Le bornier n'est pas inclus.
- Une mise à la terre correcte doit être assurée tout au long de l'installation.
- Pour l'extérieur
- Remplacer tout écran de protection fissuré. 
- Distance minimale des objets éclairés 1m. 

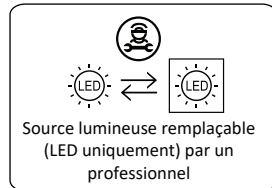

REMARQUE : Pour réduire le risque de strangulation, les câbles flexibles connectés à ce luminaire doivent être efficacement fixés au mur s'ils sont à portée de main.



Ce marquage indique que ce produit ne doit pas être éliminé avec les autres déchets ménagers.



Attention, risque de choc électrique.



FR

Cet appareil, ses accessoires et cordons se recyclent

À DÉPOSER EN MAGASIN



À DÉPOSER EN DÉCHÈTERIE



OU

Points de collecte sur www.quefairedemesdechets.fr
Privilégiez la réparation ou le don de votre appareil !

Schéma d'installation

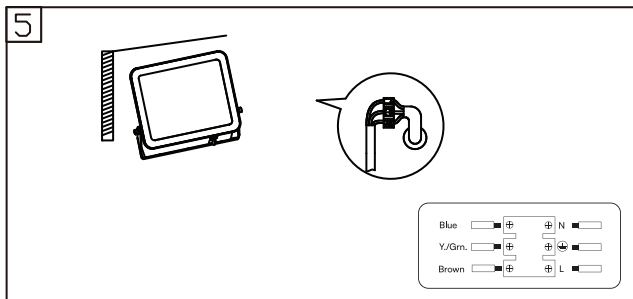
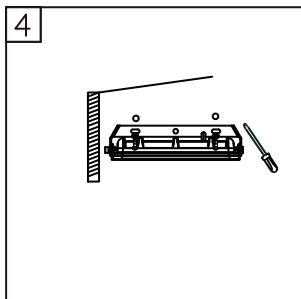
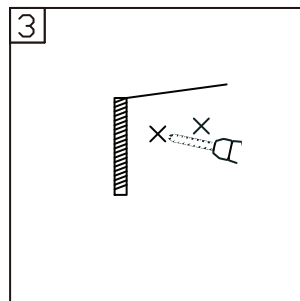
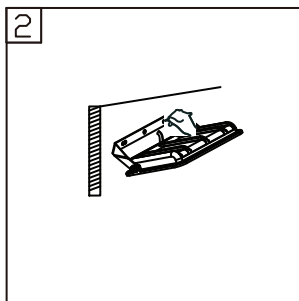
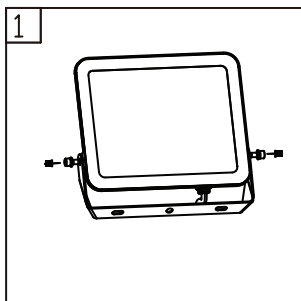

Instructions d'installation

- NE PAS UTILISER DANS DES ENDROITS PEU VENTILÉS OU EN DEHORS DE LA PLAGE DE TEMPÉRATURE AMBIANTE NOMINALE. *CONNECTER UNIQUEMENT AVEC UNE GAINÉ DE CÂBLE ÉTANCHE. *S'ASSURER QUE L'ÉLECTRICITÉ EST COUPÉE AVANT L'INSTALLATION.
- Ne pas installer l'appareil sur une surface sujette aux vibrations.
- Retirez ensuite la vis et le support. (Figure 1) Avant de percer, marquez la position du trou pour fixer le support au mur (vis non fournie). (Figure 2)
- Visser l'étrier de retenue au mur à l'aide d'une quantité appropriée de vis. (Figure 3)
- Remontez l'étrier sur le projecteur. Ajustez le projecteur en fonction de la position souhaitée. Serrez la vis. (Figure 4) Connectez votre câble principal (H05RN-F3G1.0mm2 recommandé) avec le fil d'entrée de notre produit à travers la boîte de jonction étanche. Notez la ligne (-) du câble. (Figure 5) (Nécessité d'utiliser une boîte de jonction IP65 ou supérieure, s'assurer de serrer la vis étanche) Mettre sous tension pour s'assurer que le produit fonctionne.

INSTRUCTIONS DE DÉMONTAGE

(Réservé à l'équipe de surveillance du marché)

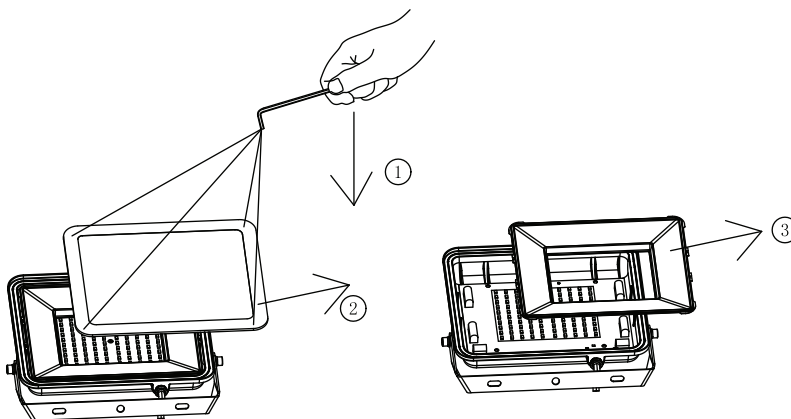

Note : Le retrait de la source lumineuse annule la garantie.



EN CAS DE QUESTION/PROBLÈME CONCERNANT LE PRODUIT, VEUILLEZ NOUS CONTACTER À L'ADRESSE SUIVANTE : SUPPORT@V-TAC.EU
POUR PLUS D'INFORMATIONS SUR LA GAMME DE PRODUITS, VEUILLEZ CONTACTER NOTRE DISTRIBUTEUR OU LE REVENDEUR LE PLUS PROCHE.
REVENDEURS LES PLUS PROCHEs. V-TAC EUROPE LTD. BULGARIA, PLOVDIV 4000, BUL.L.KARAVELOW 9B

GEBRAUCHSANWEISUNG

LED-FLUTLICHT



TECHNISCHE DATEN

MODEL	SKU	WATTS	LUMENS	BEAM ANGLE	DF	CRI	INPUT POWER	OPERATION TEMPERATURE	DIMENSION (LxWxH)	N.W. (KGS)	MAXIMALE MONTAGEHÖHE	PROJEKTIERTE FLÄCHE(mm²)	DRAHTLÄNGE
VT-44010	9898,9899,10010 10011,10012,10013	10W	735LM	115°	>0.9	>70	AC220-240V 50Hz	-20°C to +45°C	104x21x92mm	0.16	<5M	9568	0.15M
VT-44020	10014,10015,10016 10017,10018,10019	20W	1620LM	115°	>0.9	>70	AC220-240V 50Hz	-20°C to +45°C	126,5x28x114mm	0.24	<5M	14421	0.15M
VT-44030	10020,10021,10022 10023,10024,10025	30W	2505LM	115°	>0.9	>70	AC220-240V 50Hz	-20°C to +45°C	164x29x139mm	0.35	<5M	22796	0.15M
VT-44050	10026	50W	4270LM	115°	>0.9	>70	AC220-240V 50Hz	-20°C to +45°C	183x29x169mm	0.48	<5M	30927	0.15M
VT-44100	10348	100W	8700LM	115°	>0.9	>70	AC220-240V 50Hz	-20°C to +45°C	183x29x169mm	0.97	<5M	55118	1M
VT-44200	10027,10028, 10029,10030	200W	17540LM	115°	>0.9	>70	AC220-240V 50Hz	-20°C to +45°C	405x36x326mm	2.29	<5M	132030	1M
VT-44300	10031,10032 10033,10034	300W	26390LM	115°	>0.9	>70	AC220-240V 50Hz	-20°C to +45°C	496x49x445mm	4.28	<5M	220720	1M

*Dieses Produkt enthält eine Lichtquelle der Energieeffizienzklasse<F>, wobei <F> durch die Energieklasse der enthaltenen Lichtquelle zu ersetzen ist.

EINFÜHRUNG & GARANTIE

Vielen Dank, dass Sie ein V-TAC-Produkt ausgewählt und gekauft haben. V-TAC wird Ihnen die besten Dienste leisten. Bitte lesen Sie diese Anweisungen sorgfältig durch, bevor Sie mit der Installation beginnen, und bewahren Sie diese Anleitung zum späteren Nachschlagen auf. Sollten Sie weitere Fragen haben, wenden Sie sich bitte an unseren Händler oder den lokalen Verkäufer, bei dem Sie das Produkt gekauft haben. Sie sind geschult und bereit, Sie bestmöglich zu bedienen. Die Garantie gilt für 5 Jahre ab dem Kaufdatum. Die Garantie gilt nicht für Schäden, die durch unsachgemäße Installation oder abnormalen Verschleiß verursacht wurden. Das Unternehmen übernimmt keine Garantie für Schäden an Oberflächen, die durch unsachgemäßen Aus- und Einbau des Produkts entstehen. Die Produkte sind für einen täglichen Betrieb von 10-12 Stunden geeignet. Verwendung des Produkts für

24 Stunden am Tag würde die Garantie nichtig machen. Dieses Produkt ist nur für Herstellungsfehler garantiert.



**IP65
RATING**

05 YEAR
WARRANTY*

SAMSUNG
LED
Illuminated

**PRO
SERIES**

WARNUNG

- Bitte stellen Sie sicher, dass Sie den Strom abschalten, bevor Sie mit der Installation beginnen.
- Die Installation muss von einem qualifizierten Elektriker durchgeführt werden.
- Die in dieser Leuchte enthaltene Lichtquelle darf nur durch den Hersteller oder seinen Kundendienst oder eine ähnlich qualifizierte Person ausgetauscht werden.
- Wenn die äußere flexible Leitung oder das Kabel dieser Leuchte beschädigt ist, muss sie/es ausschließlich durch den Hersteller oder seinen Kundendienst oder eine ähnlich qualifizierte Person ersetzt werden, um eine Gefährdung zu vermeiden.
- Klemmenblock nicht enthalten.
- Die ordnungsgemäße Erdung sollte während der gesamten Installation gewährleistet sein.
- Für die Verwendung im Freien.
- Ersetzen Sie alle gerissenen Schutzschilde. 
- Mindestabstand zu beleuchteten Objekten 1 m. 

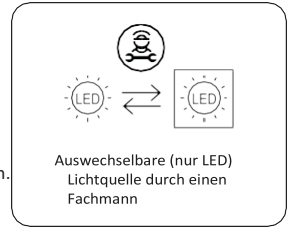

HINWEIS: Um die Gefahr einer Strangulierung zu verringern, muss das flexible Kabel, das mit dieser Leuchte verbunden ist, wirksam an der Wand befestigt werden, wenn sich das Kabel in Reichweite der Arme befindet.



Diese Kennzeichnung weist darauf hin, dass dieses Produkt nicht mit anderen Haushaltsabfällen entsorgt werden darf.



Vorsicht, Gefahr eines Stromschlags.

EINBAUSKIZZE

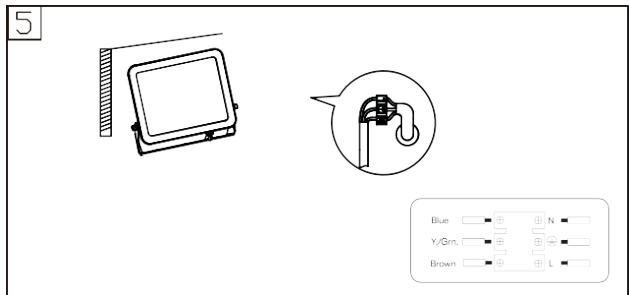
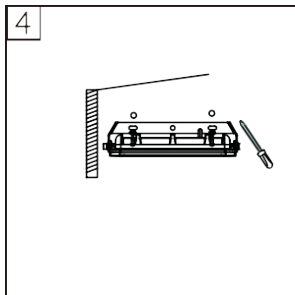
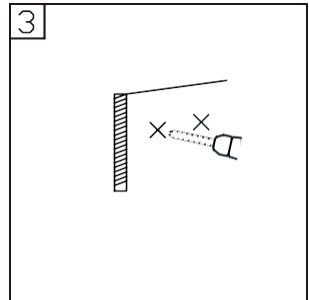
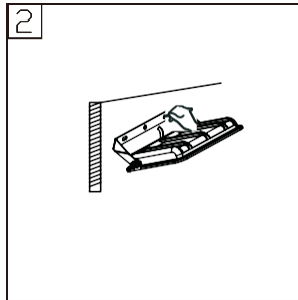
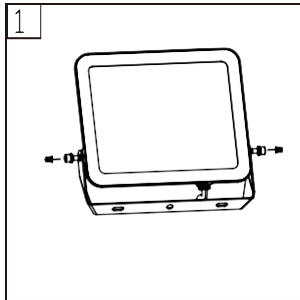

INSTALLATIONSANLEITUNG

- NICHT IN BEREICHEN MIT EINGESCHRÄNKTER BELÜFTUNG ODER AUSSERHALB DES NENN-UMGEBUNGSTEMPERATURBEREICHS VERWENDEN. *NUR MIT WASSERDICHEM KABELGEHÄUSE ANSCHLIESSEN. *STELLEN SIE SICHER, DASS DER STROM VOR DER INSTALLATION ABGESCHALTET IST.
- Bitte nicht auf einer Oberfläche montieren, die zu Vibrationen neigt.
- Entfernen Sie anschließend die Schraube und die Halterung. (Abbildung 1) Markieren Sie vor dem Bohren die Position des Lochs für die Befestigung der Halterung an der Wand (Schraube nicht im Lieferumfang enthalten). (Abbildung 2)
- Schrauben Sie den Haltebügel mit einer geeigneten Anzahl von Schrauben an der Wand fest. (Abbildung 3)
- Montieren Sie den Bügel wieder an der Halterung. Stellen Sie den Scheinwerfer entsprechend der gewünschten Position ein. Ziehen Sie die Schraube fest. (Abbildung 4) Verbinden Sie Ihr Hauptkabel (H05RN-F3G1.0mm2 empfohlen) mit dem Eingangskabel unseres Produktes durch die wasserdichte Anschlussdose. Beachten Sie die Leitung (-) des Kabels. (Abbildung 5) (Verwenden Sie eine Anschlussdose der Schutzart IP65 oder höher, ziehen Sie die wasserdichte Schraube fest) Schalten Sie den Strom ein, um sicherzustellen, dass das Produkt funktioniert.

DEMONTAGEANLEITUNG

(Nur für das Marktüberwachungsteam)

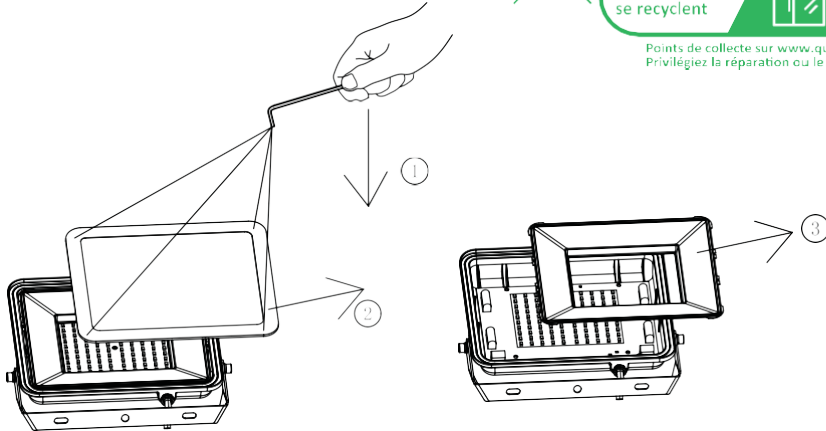

Hinweis: Die Entfernung der Lichtquelle führt zum Erlöschen der Garantie.



FALLS SIE FRAGEN ODER PROBLEME MIT DEM PRODUKT HABEN, WENDEN SIE SICH BITTE AN UNS UNTER: SUPPORT@V-TAC.EU. FÜR WEITERE PRODUKTE UND ANFRAGEN WENDEN SIE SICH BITTE AN UNSEREN VERTRIEBSPARTNER ODER DEN NÄCHSTGELEGENEN HÄNDLER.

V-TAC EUROPE LTD. BULGARIEN, PLOVDIV 4000, BUL.L.KARAVELOW 9B

WICHTIGE HINWEISE

- Elektro- und Elektronikgeräte, die zu Abfall geworden sind, werden als Altgeräte bezeichnet. Altgeräte dürfen nicht mit anderem Hausmüll entsorgt werden.
- Besitzer von Altgeräten am Ende der Nutzungsdauer müssen das Gerät bei den von den öffentlichen Entsorgungsträgern oder Händlern eingerichteten Sammelstellen zurückgeben. Diese Rücksendung ist für Sie mit keinen Kosten verbunden.
- Besitzer von Altgeräten sind verpflichtet, Lampen vor der Rückgabe zerstörungsfrei aus dem Altgerät zu entfernen.



- Das Symbol „Gekreuzte Mülltonnen“ weist darauf hin, dass dieses Produkt nicht mit dem anderen Hausmüll entsorgt werden darf und am Ende seiner Lebensdauer vom unsortierten Hausmüll getrennt gesammelt werden muss.
 - Bei der Entsorgung von Elektrogeräten auf Deponien oder Halden können Schadstoffe ins Grundwasser gelangen und in die Nahrungskette gelangen und Ihre Gesundheit und Ihr Wohlbefinden schädigen.
 - Unter folgendem Link gelangen Sie zum Online-Verzeichnis der Sammel- und Rückgabestellen: <https://www.ear-system.de/ear-verzeichnis/sammel-und-ruecknahmestellen>
-

ΕΓΧΕΙΡΙΔΙΟ ΟΔΗΓΙΩΝ

ΟΔΗΓΗΣΕ ΠΛΗΜΜΥΡΑΣ ΦΩΣ



ΤΕΧΝΙΚΑ ΣΤΟΙΧΕΙΑ

ΜΟΔΕΛ	SKU	WATTS	LUMENS	BEAM ANGLE	DF	CRI	INPUT POWER	OPERATION TEMPERATURE	DIMENSION (LxWxH)	N.W. (KGS)	ΜΕΓΙΣΤΟ ΎψΟΣ ΤΟΠΟΘΕΤΗΣΗΣ	ΠΡΟΒΛΕΠΟΜΕΝΟ ΠΕΡΙΟΧΗ (mm ²)	ΜΗΚΟΣ ΣΥΡΜΑΤΟΣ
VT-44010	9898,9899,10010 10011,10012,10013	10W	735LM	115°	>0.9	>70	AC220-240V 50Hz	-20°C to +45°C	104x21x92mm	0.16	<5M	9568	0.15M
VT-44020	10014,10015,10016 10017,10018,10019	20W	1620LM	115°	>0.9	>70	AC220-240V 50Hz	-20°C to +45°C	126.5x28x114mm	0.24	<5M	14421	0.15M
VT-44030	10020,10021,10022 10023,10024,10025	30W	2505LM	115°	>0.9	>70	AC220-240V 50Hz	-20°C to +45°C	164x29x139mm	0.35	<5M	22796	0.15M
VT-44050	10026	50W	4270LM	115°	>0.9	>70	AC220-240V 50Hz	-20°C to +45°C	183x29x169mm	0.48	<5M	30927	0.15M
VT-44100	10348	100W	8700LM	115°	>0.9	>70	AC220-240V 50Hz	-20°C to +45°C	183x29x169mm	0.97	<5M	55118	1M
VT-44200	10027,10028, 10029,10030	200W	17540LM	115°	>0.9	>70	AC220-240V 50Hz	-20°C to +45°C	405x36x326mm	2.29	<5M	132030	1M
VT-44300	10031,10032 10033,10034	300W	26390LM	115°	>0.9	>70	AC220-240V 50Hz	-20°C to +45°C	496x49x445mm	4.28	<5M	220720	1M

*Αυτό το προϊόν περιέχει φωτεινή πηγή κλάσης ενεργειακής απόδοσης <F>, όπου το <F> αντικαθίσταται από την ενεργειακή κλάση της φωτεινής πηγής που περιέχεται.

ΕΙΣΑΓΩΓΗ & ΕΓΓΥΗΣΗ

Σας ευχαριστούμε που επιλέξατε και αγοράσατε το προϊόν V-TAC. Η V-TAC θα σας εξυπηρετήσει με τον καλύτερο τρόπο. Παρακαλούμε διαβάστε προσεκτικά αυτές τις οδηγίες πριν ξεκινήσετε την εγκατάσταση και κρατήστε αυτό το εγχειρίδιο πρόχειρο για μελλοντική αναφορά. Εάν έχετε οποιαδήποτε άλλη απορία, παρακαλούμε επικοινωνήστε με τον αντιπρόσωπο μας ή τον τοπικό πωλητή από τον οποίο αγοράσατε το προϊόν. Είναι εκπαιδευμένοι και έτοιμοι να σας εξυπηρετήσουν με τον καλύτερο τρόπο. Η εγγύηση ισχύει για 5 χρόνια από την ημερομηνία αγοράς. Η εγγύηση δεν ισχύει για ζημιές που προκαλούνται από εσφαλμένη εγκατάσταση ή μη φυσιολογική φθορά. Η εταιρεία δεν παρέχει καμία εγγύηση για ζημιές σε οποιαδήποτε επιφάνεια λόγω λανθασμένης αφαίρεσης και εγκατάστασης του προϊόντος. Τα προϊόντα είναι κατάλληλα για 10-12 ώρες καθημερινής λειτουργίας. Χρήση του προϊόντων για 24 ώρες την ημέρα θα ακυρώσει την εγγύηση. Αυτό το προϊόν έχει εγγύηση μόνο για κατασκευαστικά ελαττώματα.



**IP65
RATING**

**05
YEAR
WARRANTY***

**SAMSUNG
LED**
Illuminated

**PRO
SERIES**

ΠΡΟΕΙΔΟΠΟΙΗΣΗ

- Βεβαιωθείτε ότι έχετε απενεργοποιήσει το ρεύμα πριν ξεκινήσετε την εγκατάσταση.
- Η εγκατάσταση πρέπει να γίνεται από εξειδικευμένο ηλεκτρολόγο.
- Η φωτεινή πηγή που περιέχεται σε αυτό το φωτιστικό πρέπει να αντικαθίσταται μόνο από τον κατασκευαστή ή τον αντιπρόσωπο σέρβις του ή από παρόμοιο εξειδικευμένο άτομο.
- Εάν το εξωτερικό εύκαμπτο καλώδιο ή το καλώδιο αυτού του φωτιστικού έχει υποστεί ζημιά, πρέπει να αντικαθίσταται αποκλειστικά από τον κατασκευαστή ή τον αντιπρόσωπο σέρβις του ή από παρόμοιο ειδικευμένο άτομο, προκειμένου να αποφευχθεί κίνδυνος.
- Το μπλοκ ακροδεκτών δεν περιλαμβάνεται.
- Η σωστή γείωση πρέπει να εξασφαλίζεται σε όλη την εγκατάσταση.
- Για εξωτερική χρήση.
- Αντικαταστήστε κάθε ραγισμένη προστατευτική ασπίδα. 
- Ελάχιστη απόσταση από φωτισμένα αντικείμενα 1m. 

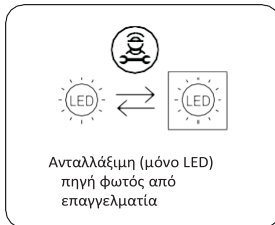

ΣΗΜΕΙΩΣΗ: Για να μειωθεί ο κίνδυνος στραγγαλισμού, τα εύκαμπτα καλώδια που συνδέονται με αυτό το φωτιστικό πρέπει να στερεώνονται αποτελεσματικά στον τοίχο, εάν τα καλώδια βρίσκονται σε απόσταση αναπνοής.



Η σήμανση αυτή υποδεικνύει ότι το προϊόν αυτό δεν πρέπει να απορρίπτεται μαζί με άλλα οικιακά απόβλητα.



Προσοχή, κίνδυνος ηλεκτροπληξίας.

ΔΙΑΓΡΑΜΜΑ ΕΓΚΑΤΑΣΤΑΣΗΣ

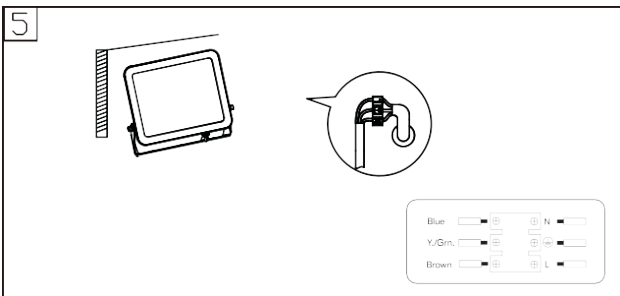
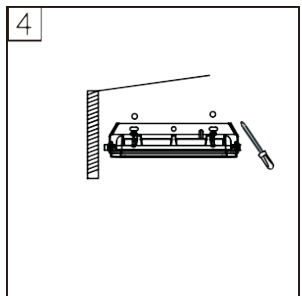
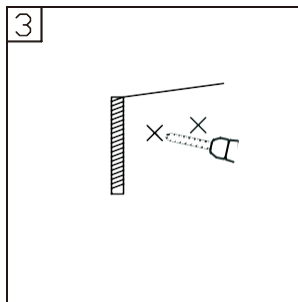
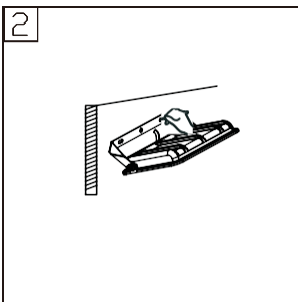
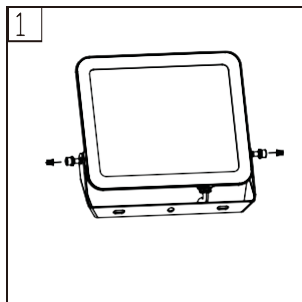

ΟΔΗΓΙΕΣ ΕΓΚΑΤΑΣΤΑΣΗΣ

- ΜΗΝ ΤΟ ΧΡΗΣΙΜΟΠΟΙΕΙΤΕ ΣΕ ΧΩΡΟΥΣ ΜΕ ΠΕΡΙΟΡΙΣΜΕΝΟ ΕΞΑΕΡΙΣΜΟ Ή ΕΚΤΟΣ ΤΟΥ ΟΝΟΜΑΣΤΙΚΟΥ ΕΥΡΟΥΣ ΘΕΡΜΟΚΡΑΣΙΩΝ ΠΕΡΙΒΑΛΛΟΝΤΟΣ. *ΣΥΝΔΕΣΤΕ ΜΟΝΟ ΜΕ ΑΔΙΑΒΡΟΧΟ ΚΑΛΩΔΙΟ. *ΕΞΑΣΦΑΛΙΣΤΕ ΟΤΙ ΤΟ ΗΛΕΚΤΡΙΚΟ ΡΕΥΜΑ ΕΙΝΑΙ ΑΠΕΝΕΡΓΟΠΟΙΗΜΕΝΟ ΠΡΙΝ ΑΠΟ ΤΗΝ ΕΓΚΑΤΑΣΤΑΣΗ.
- Μην τοποθετείτε σε επιφάνεια που είναι επιρρεπής σε δονήσεις.*
- Στη συνέχεια αφαιρέστε τη βίδα και το στήριγμα. (Εικόνα 1) Πριν από τη διάτρηση, σημειώστε τη θέση της οπής για τη στερέωση του βραχίονα στον τοίχο (η βίδα δεν παρέχεται). (Εικόνα 2)
- Βιδώστε το στήριγμα συγκράτησης στον τοίχο με κατάλληλη ποσότητα βιδών. (Εικόνα 3)
- Τοποθετήστε το στήριγμα πίσω στο φωτιστικό. Ρυθμίστε τον προβολέα σύμφωνα με την επιθυμητή θέση. Σφίξτε τη βίδα. (Εικόνα 4) Συνδέστε το κύριο καλώδιο (H05RN-F3G1.0mm2 Συνιστάται) με το καλώδιο εισόδου του προϊόντος μας μέσω του αδιάβροχου κουτιού σύνδεσης. Σημειώστε, τη γραμμή (-) του καλωδίου. (Εικόνα 5) (Πρέπει να χρησιμοποιήσετε το κουτί διακλάδωσης IP65 ή παραπάνω, βεβαιωθείτε ότι έχετε σφίξει την αδιάβροχη βίδα) Ενεργοποιήστε το ρεύμα για να βεβαιωθείτε ότι το προϊόν λειτουργεί.

ΟΔΗΓΙΕΣ ΑΠΟΣΥΝΑΡΜΟΛΟΓΗΣΗΣ

(Μόνο για την ομάδα εποπτείας της αγοράς)

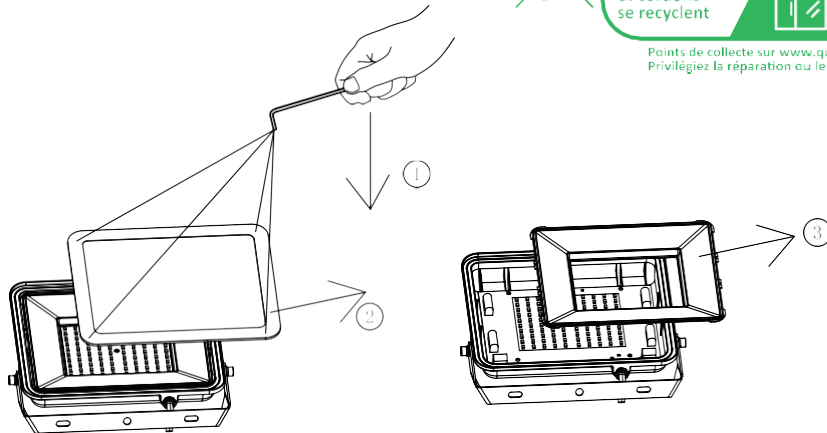

Σημείωση: Η αφαίρεση της πηγής φωτός ακυρώνει την εγγύηση



ΣΕ ΠΕΡΙΠΤΩΣΗ ΟΠΟΙΟΥΔΗΠΟΤΕ ΕΡΩΤΗΜΑΤΟΣ/ΠΡΟΒΛΗΜΑΤΟΣ ΜΕ ΤΟ ΠΡΟΪΟΝ, ΠΑΡΑΚΑΛΟΥΜΕ ΕΠΙΚΟΙΝΩΝΗΣΤΕ ΜΑΖΙ ΜΑΣ ΣΤΟ: SUPPORT@V-TAC.EU ΓΙΑ ΠΕΡΙΣΣΟΤΕΡΗ ΣΕΙΡΑ ΠΡΟΪΟΝΤΩΝ, ΉΡΕΥΝΑ ΠΑΡΑΚΑΛΟΥΜΕ ΕΠΙΚΟΙΝΩΝΗΣΤΕ ΜΕ ΤΟΝ ΔΙΑΝΟΜΕΑ ΜΑΣ Ή ΤΟΥΣ ΠΛΗΣΙΕΣΤΕΡΟΥΣ ΑΝΤΙΠΡΟΣΩΠΟΥΣ.
V-TAC EUROPE LTD. ΒΟΥΛΓΑΡΙΑ, ΠΛΟΒΝΤΙΒ 4000, BUL.L.KARAVELOW 9B

HASZNÁLATI ÚTMUTATÓ

LED ÁRVÍZFÉNY



TECHNIKAI ADATOK

MÓDEL	SKU	WATTS	LUMENS	BEAM ANGLE	DF	CRI	INPUT POWER	OPERATION TEMPERATURE	DIMENSION (LxWxH)	N.W. (KGS)	MAXIMÁLIS BEÉPÍTÉSI MAGASSÁG	PROJECED TERÜLET(mm ²)	VEZETÉK HOSSZÚJA
VT-44010	9898,9899,10010 10011,10012,10013	10W	735LM	115°	>0.9	>70	AC220-240V 50Hz	-20°C to +45°C	104x21x92mm	0.16	<5M	9568	0.15M
VT-44020	10014,10015,10016 10017,10018,10019	20W	1620LM	115°	>0.9	>70	AC220-240V 50Hz	-20°C to +45°C	126.5x28x114mm	0.24	<5M	14421	0.15M
VT-44030	10020,10021,10022 10023,10024,10025	30W	2505LM	115°	>0.9	>70	AC220-240V 50Hz	-20°C to +45°C	164x29x139mm	0.35	<5M	22796	0.15M
VT-44050	10026	50W	4270LM	115°	>0.9	>70	AC220-240V 50Hz	-20°C to +45°C	183x29x169mm	0.48	<5M	30927	0.15M
VT-44100	10348	100W	8700LM	115°	>0.9	>70	AC220-240V 50Hz	-20°C to +45°C	183x29x169mm	0.97	<5M	55118	1M
VT-44200	10027,10028, 10029,10030	200W	17540LM	115°	>0.9	>70	AC220-240V 50Hz	-20°C to +45°C	405x36x326mm	2.29	<5M	132030	1M
VT-44300	10031,10032 10033,10034	300W	26390LM	115°	>0.9	>70	AC220-240V 50Hz	-20°C to +45°C	496x49x445mm	4.28	<5M	220720	1M

*Ez a termék <F> energiahatékonysági osztályú fényforrást tartalmaz, ahol az <F> helyett a benne lévő fényforrás energiaoosztályát kell feltüntetni.

BEVEZETÉS ÉS GARANCIA

Köszönjük, hogy V-TAC terméket választott és vásárolt. A V-TAC a legjobbat fogja nyújtani Önnek. Kérjük, olvassa el figyelmesen ezeket az utasításokat, mielőtt elkezdi a telepítést, és tartsa kéznél ezt a kézikönyvet a későbbi használatra. Ha bármilyen más kérdése van, kérjük, forduljon a kereskedőnközhöz vagy a helyi forgalmazóhoz, akitől a terméket vásárolta. Ők képzettek és készen állnak arra, hogy a lehető legjobban kiszolgálják Önt. A garancia a vásárlástól számított 5 évig érvényes. A garancia nem vonatkozik a helytelen telepítés vagy rendellenes elhasználódás okozta károokra. A vállalat nem vállal garanciát a termék helytelen eltávolítása és beszerelése miatt bármely felületen keletkezett károokra. A termékek napi 10-12 órák működésre alkalmasak. A termék használata

A napi 24 órás üzemmód érvényteleníté a garanciát. Erre a termékre kizárólag gyártási hibák esetén vállalunk garanciát.



**IP65
RATING**

**05
YEAR
WARRANTY***

**SAMSUNG
LED
Illuminated**

**PRO
SERIES**

FIGYELMEZTETÉS

- A telepítés megkezdése előtt feltétlenül kapcsolja ki a készüléket.
- A beszerelést szakképzett villanyszerelőnek kell elvégeznie.
- A lámpatestben található fényforrást csak a gyártó vagy annak szervizügynöke, illetve hasonló képesséssel rendelkező személy cserélheti ki.
- Ha a lámpatest külső hajlékony kábele vagy zsinórja megsérül, azt a veszély elkerülése érdekében kizárólag a gyártónak vagy szervizének, illetve hasonló képesséssel rendelkező személynek kell kicserélnie.
- A csatlakozóblokk nem tartozék.
- Az egész telepítés során biztosítani kell a megfelelő földelést.
- Kültéri használatra.
- Cserélje ki a repedt védőpajzsot. 
- Minimális távolság a megvilágított tárgytól 1m. 



Szakember által cserélhető
(csak LED) fényforrás

MEGJEGYZÉS: A foltogatas veszélyének csökkentése érdekében a lámpatesthez csatlakoztatott hajlékony vezetékeket hatékonyan a falhoz kell rögzíteni, ha a vezeték karnyújtásnyira van.



Ez a jelölés azt jelzi, hogy ezt a terméket nem szabad más háztartási hulladékkal együtt ártalmatlanítani.



Vigyázat, áramütés veszélye.

TELEPÍTÉSI DIAGRAM

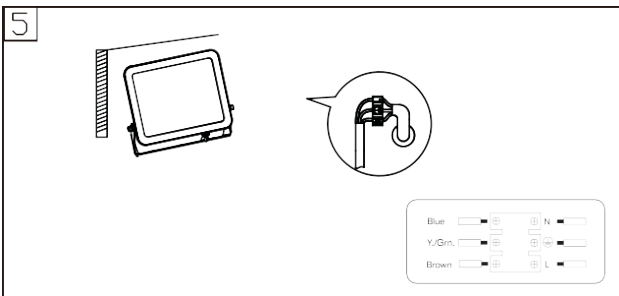
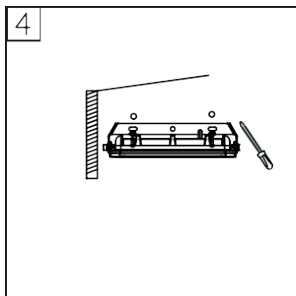
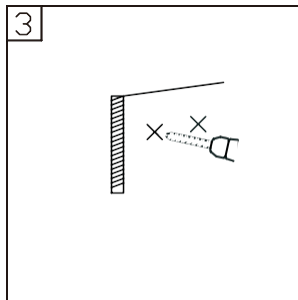
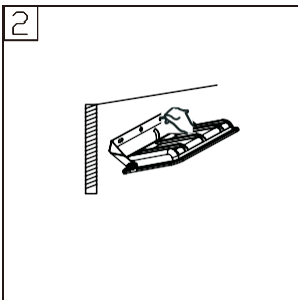
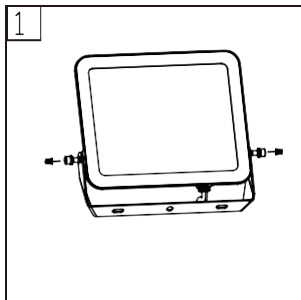

TELEPÍTÉSI UTASÍTÁS

- NE HASZNÁLJA KORLÁTOZOTT SZELLŐZÉSŰ HELYSÉGEKBEN VAGY A NÉVLEGES KÖRNYEZETI HŐMÉRSÉKLET-TARTOMÁNYON KÍVÜL. *KIZÁRÓLAG VÍZÁLLÓ KÁBELHÁZZAL CSATLAKOZTASSA. *GYŐZŐDJÖN MEG RÓLA, HOGY A TELEPÍTÉS ELŐTT KIKAPCSOLTÁK AZ ÁRAMOT.
- Kérjük, ne szerelje olyan felületre, amely hajlamos a rezgésekre.*
- Ezt követően távolítsa el a csavart és a konzolt. (1. ábra) Fúrás előtt jelölje meg a furat helyét a konzol falra történő rögzítéséhez (a csavar nem tartozék). (2. ábra)
- Csavarozza a tartókonzolt a falhoz megfelelő mennyiségű csavarral. (3. ábra)
- Szerelje vissza a konzolt a lámpatestre. Állítsa be a reflektort a kívánt pozíciónak megfelelően. Húzza meg a csavart. (4. ábra) Csatlakoztassa a főkábelt (H05RN-F3G1,0mm2 ajánlott) a termékünk bemeneti vezetékéhez a vízálló csatlakozódobozon keresztül. Vegye figyelembe, a vezeték (-) vonalát. (5. ábra) (IP65 vagy annál magasabb IP65 csatlakozódobozt kell használnia, gondoskodjon a vízálló csavar meghúzásáról) Kapcsolja be a készüléket, hogy meggyőződjön arról, hogy a termék működik-e.

SZÉTSZERELÉSI ÚTMUTATÓ (Csak a piacfelügyeleti csoport számára)

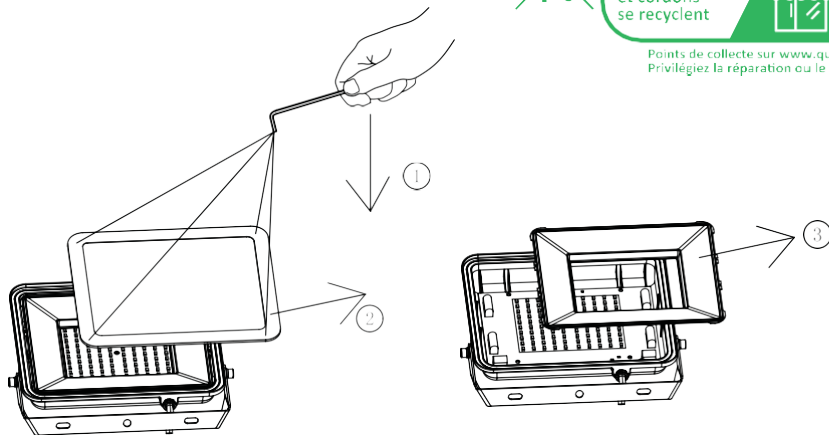

Megjegyzés: A fényforrás eltávolítása érvényteleníti a garanciát



RoHS



UK
CA



A TERMÉKKEL KAPCSOLATOS BÁRMILYEN KÉRDÉS/PROBLÉMA ESETÉN KÉRJÜK, FORDULJON HOZZÁNK A KÖVETKEZŐ CÍMEN: SUPPORT@V-TAC.EU TOVÁBBI TERMÉKVÁLASZTÉKÉRT, ÉRDEKLŐDÉSÉRT KÉRJÜK, LÉPJEN KAPCSOLATBA FORGALMAZÓNKKAL VAGY A LEGKÖZELEBBI KERESKEDŐINKEL.

V-TAC EUROPE LTD. BULGÁRIA, PLOVDIV 4000, BUL.L.KARAVELOW 9B

MANUALE DI ISTRUZIONI

LUCE DI INONDAZIONE A LED



DATI TECNICI

MODEL	SKU	WATTS	LUMENS	BEAM ANGLE	DF	CRI	INPUT POWER	OPERATION TEMPERATURE	DIMENSION (LxWxH)	N.W. (KGS)	ALTEZZA MASSIMA DI MONTAGGIO	PROGETTATO AREA(mm²)	LUNGHEZZA DEL FILO
VT-44010	9898,9899,10010 10011,10012,10013	10W	735LM	115°	>0.9	>70	AC220-240V 50Hz	-20°C to +45°C	104x21x92 mm	0.16	<5M	9568	0.15M
VT-44020	10014,10015,10016 10017,10018,10019	20W	1620LM	115°	>0.9	>70	AC220-240V 50Hz	-20°C to +45°C	126,5x28x114 mm	0.24	<5M	14421	0.15M
VT-44030	10020,10021,10022 10023,10024,10025	30W	2505LM	115°	>0.9	>70	AC220-240V 50Hz	-20°C to +45°C	164x29x139 mm	0.35	<5M	22796	0.15M
VT-44050	10026	50W	4270LM	115°	>0.9	>70	AC220-240V 50Hz	-20°C to +45°C	183x29x169 mm	0.48	<5M	30927	0.15M
VT-44100	10348	100W	8700LM	115°	>0.9	>70	AC220-240V 50Hz	-20°C to +45°C	183x29x169 mm	0.97	<5M	55118	1M
VT-44200	10027,10028, 10029,10030	200W	17540LM	115°	>0.9	>70	AC220-240V 50Hz	-20°C to +45°C	405x36x326 mm	2.29	<5M	132030	1M
VT-44300	10031,10032 10033,10034	300W	26390LM	115°	>0.9	>70	AC220-240V 50Hz	-20°C to +45°C	496x49x445 mm	4.28	<5M	220720	1M

*Questo prodotto contiene una sorgente luminosa di classe di efficienza energetica<F>, dove <F> è sostituito dalla classe energetica della sorgente luminosa contenuta.

INTRODUZIONE E GARANZIA

Grazie per aver scelto e acquistato un prodotto V-TAC. V-TAC vi servirà al meglio. Si prega di leggere attentamente le istruzioni prima di iniziare l'installazione e di tenere il manuale a portata di mano per future consultazioni. Per qualsiasi altra domanda, contattare il nostro rivenditore o il venditore locale presso il quale è stato acquistato il prodotto. Sono addestrati e pronti a servirvi al meglio. La garanzia è valida per 5 anni dalla data di acquisto. La garanzia non si applica ai danni causati da un'installazione non corretta o da un'usura anomala. L'azienda non fornisce alcuna garanzia contro i danni a qualsiasi superficie dovuti a un'errata rimozione e installazione del prodotto. I prodotti sono adatti per un funzionamento giornaliero di 10-12 ore. Utilizzo del prodotto per

24 ore su 24 annullerebbe la garanzia. Questo prodotto è garantito solo per i difetti di fabbricazione.

**IP65
RATING**

**05
YEAR
WARRANTY***

**SAMSUNG
LED
Illuminated**

**PRO
SERIES**

ATTENZIONE

- Assicurarsi di spegnere l'alimentazione prima di iniziare l'installazione.
- L'installazione deve essere eseguita da un elettricista qualificato.
- La sorgente luminosa contenuta in questo apparecchio deve essere sostituita solo dal produttore o dal suo agente di assistenza o da una persona qualificata simile.
- Se il cavo flessibile esterno o il cavo di questo apparecchio è danneggiato, deve essere sostituito esclusivamente dal produttore o dal suo agente di assistenza o da una persona qualificata simile, al fine di evitare un pericolo.
- La morsetteria non è inclusa.
- È necessario garantire una messa a terra adeguata per tutta la durata dell'installazione.
- Per uso esterno.
- Sostituire lo schermo protettivo incrinato.
- Distanza minima da oggetti illuminati 1 m.



NOTA: Per ridurre il rischio di strangolamento, il cavo flessibile collegato a questo apparecchio deve essere efficacemente fissato alla parete se il cavo è a portata di mano.



Questo marchio indica che questo prodotto non deve essere smaltito con altri rifiuti domestici.



Attenzione, rischio di scosse elettriche.

SCHEMA DI INSTALLAZIONE

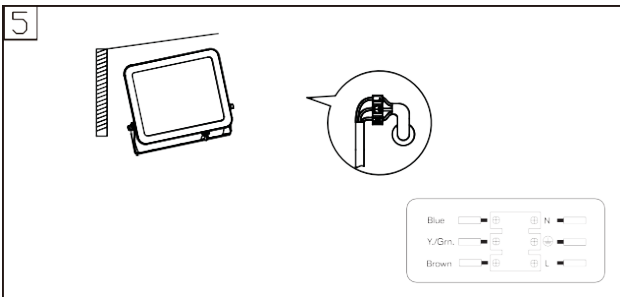
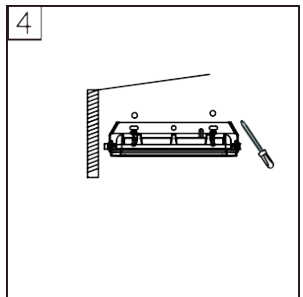
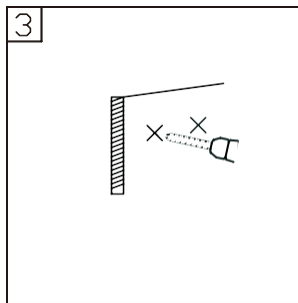
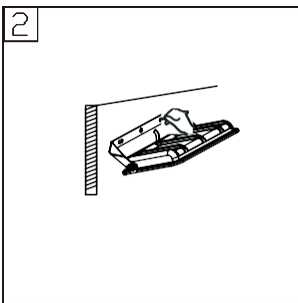
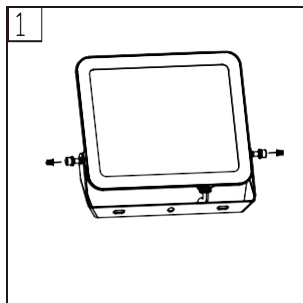

ISTRUZIONI PER L'INSTALLAZIONE

- NON UTILIZZARE IN AREE CON VENTILAZIONE LIMITATA O AL DI FUORI DELL'INTERVALLO DI TEMPERATURA AMBIENTE NOMINALE. *COLLEGARE SOLO CON UN PASSACAVO IMPERMEABILE. *ASSICURARSI CHE L'ELETTRICITÀ SIA SPENTA PRIMA DELL'INSTALLAZIONE.
- Non montare su una superficie soggetta a vibrazioni.
- Rimuovere poi la vite e la staffa. (Figura 1) Prima di forare, segnare la posizione del foro per fissare la staffa alla parete (vite non fornita). (Figura 2)
- Avvitare la staffa di fissaggio alla parete con una quantità adeguata di viti. (Figura 3)
- Montare la staffa sull'apparecchio. Regolare il proiettore in base alla posizione desiderata. Serrare la vite. (Figura 4)
- Collegare il cavo principale (H05RN-F3G1.0mm2 consigliato) con il cavo di ingresso del nostro prodotto attraverso la scatola di giunzione impermeabile. Osservare la linea (-) del cavo. (Figura 5) (È necessario utilizzare una scatola di giunzione con grado di protezione IP65 o superiore, assicurarsi di stringere la vite impermeabile) Accendere il prodotto per verificare che funzioni.

ISTRUZIONI PER LO SMONTAGGIO

(Solo per il team di sorveglianza del mercato)

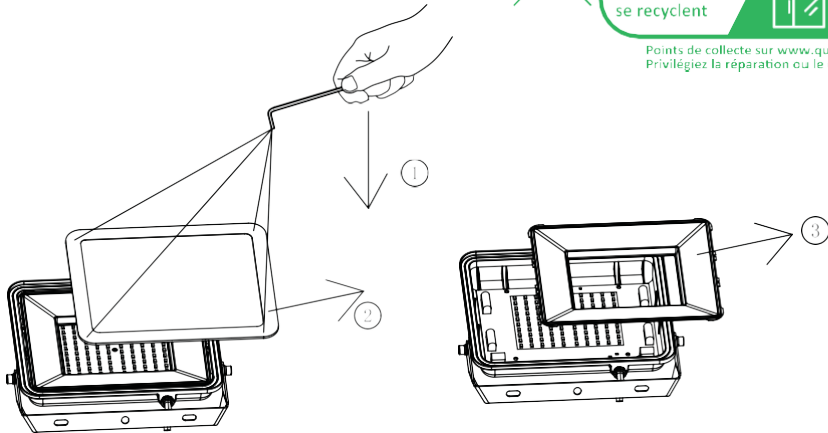

Nota: la rimozione della sorgente luminosa invalida la garanzia



IN CASO DI DOMANDE/PROBLEMI CON IL PRODOTTO, CONTATTATECI ALL'INDIRIZZO: SUPPORT@V-TAC.EU PER ULTERIORI INFORMAZIONI SULLA GAMMA DI PRODOTTI, SI PREGA DI CONTATTARE IL NOSTRO DISTRIBUTORE O I RIVENDITORI PIÙ VICINI.

V-TAC EUROPE LTD. BULGARIA, PLOVDIV 4000, BULL.KARAELOW 9B

INSTRUKCJA OBSŁUGI

LED FLOOD LIGHT



DANE TECHNICZNE

MODEL	SKU	WATTS	LUMENS	BEAM ANGLE	DF	CRI	INPUT POWER	OPERATION TEMPERATURE	DIMENSION (LxWxH)	N.W. (KGS)	MAKSYMALNA WYSOKOŚĆ MONTAŻU	PROJEKTOWANA POWIERZCHNIA (mm ²)	DŁUGOŚĆ PRZEWODU
VT-44010	9898,9899,10010 10011,10012,10013	10W	735LM	115°	>0.9	>70	AC220-240V 50Hz	-20°C to +45°C	104x21x92mm	0.16	<5M	9568	0.15M
VT-44020	10014,10015,10016 10017,10018,10019	20W	1620LM	115°	>0.9	>70	AC220-240V 50Hz	-20°C to +45°C	126,5x28x114 mm	0.24	<5M	14421	0.15M
VT-44030	10020,10021,10022 10023,10024,10025	30W	2505LM	115°	>0.9	>70	AC220-240V 50Hz	-20°C to +45°C	164x29x139mm	0.35	<5M	22796	0.15M
VT-44050	10026	50W	4270LM	115°	>0.9	>70	AC220-240V 50Hz	-20°C to +45°C	183x29x169mm	0.48	<5M	30927	0.15M
VT-44100	10348	100W	8700LM	115°	>0.9	>70	AC220-240V 50Hz	-20°C to +45°C	183x29x169mm	0.97	<5M	55118	1M
VT-44200	10027,10028, 10029,10030	200W	17540LM	115°	>0.9	>70	AC220-240V 50Hz	-20°C to +45°C	405x36x326mm	2.29	<5M	132030	1M
VT-44300	10031,10032 10033,10034	300W	26390LM	115°	>0.9	>70	AC220-240V 50Hz	-20°C to +45°C	496x49x445mm	4.28	<5M	220720	1M

*Ten produkt zawiera źródło światła o klasie efektywności energetycznej <F>, gdzie <F> należy zastąpić klasą energetyczną zawartego źródła światła.

WPROWADZENIE I GWARANCJA

Dziękujemy za wybranie i zakup produktu V-TAC. V-TAC będzie służył jak najlepiej. Przed rozpoczęciem instalacji należy uważnie przeczytać niniejszą instrukcję i zachować ją do wykorzystania w przyszłości. W przypadku jakichkolwiek innych pytań prosimy o kontakt z naszym dealerem lub lokalnym sprzedawcą, od którego zakupiono produkt. Są oni przeszkoleni i gotowi do świadczenia usług na najwyższym poziomie. Gwarancja jest ważna przez 5 lat od daty zakupu. Gwarancja nie obejmuje uszkodzeń spowodowanych nieprawidłową instalacją lub nadmiernym zużyciem. Firma nie udziela gwarancji na uszkodzenia powierzchni spowodowane nieprawidłowym demontażem i montażem produktu. Produkty są odpowiednio do pracy przez 10-12 godzin dziennie. Zastosowanie produktu do 24 godziny na dobę spowoduje unieważnienie gwarancji. Ten produkt jest objęty gwarancją wyłącznie na wady produkcyjne.



**IP65
RATING**

**05
YEAR
WARRANTY***

**SAMSUNG
LED
Illuminated**

**PRO
SERIES**

OSTRZEŻENIE

- Przed rozpoczęciem instalacji należy wyłączyć zasilanie.
- Instalacja musi zostać przeprowadzona przez wykwalifikowanego elektryka.
- Źródło światła zawarte w tej oprawie oświetleniowej może być wymieniane wyłącznie przez producenta lub jego przedstawiciela serwisowego lub podobną wykwalifikowaną osobę.
- Jeśli zewnętrzny elastyczny kabel lub przewód tej oprawy oświetleniowej zostanie uszkodzony, powinien zostać wymieniony wyłącznie przez producenta lub jego przedstawiciela serwisowego lub podobną wykwalifikowaną osobę w celu uniknięcia zagrożenia.
- Listwa zaciskowa nie wchodzi w skład zestawu.
- Podczas całej instalacji należy zapewnić prawidłowe uziemienie.
- Do użytku na zewnątrz.
- Wymień pękniętą osłonę ochronną. 
- Minimalna odległość od oświetlonych obiektów 1 m. 



UWAGA: Aby zmniejszyć ryzyko uduszenia, elastyczne przewody podłączone do tej oprawy powinny być skutecznie przymocowane do ściany, jeśli przewody znajdują się w zasięgu ręki.



To oznaczenie wskazuje, że tego produktu nie należy wyrzucać razem z innymi odpadami domowymi.



Uwaga, ryzyko porażenia prądem.

SCHEMAT INSTALACJI

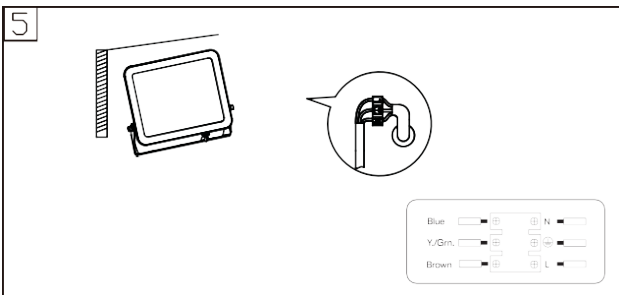
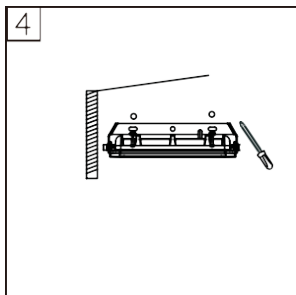
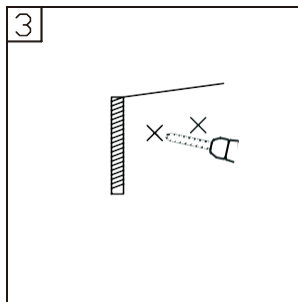
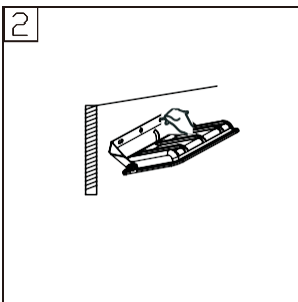
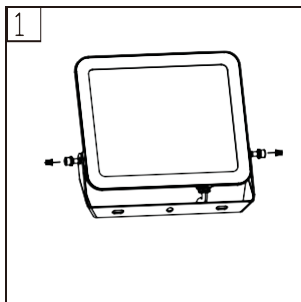

INSTRUKCJA INSTALACJI

- NIE UŻYWAĆ W MIEJSCACH O OGRANICZONEJ WENTYLACJI LUB POZA ZNAMIONOWYM ZAKRESEM TEMPERATURY OTOCZENIA. *PODŁĄCZAĆ WYŁĄCZNIE ZA POMOCĄ WODOODPORNEGO KABLA. *PRZED INSTALACJĄ NALEŻY ODŁĄCZYĆ ZASILANIE ELEKTRYCZNE.
- Nie należy montować urządzenia na powierzchniach podatnych na wibracje.
- Następnie należy usunąć śrubę i wspornik. (Rysunek 1) Przed wierceniem zaznacz położenie otworu do zamocowania wspornika na ścianie (śruba nie znajduje się w zestawie). (Rysunek 2)
- Przykręć wspornik mocujący do ściany za pomocą odpowiedniej liczby śrub. (Rysunek 3)
- Zamontuj wspornik z powrotem do urządzenia. Wyreguluj reflektor zgodnie z żądaną pozycją. Dokręć śrubę. (Rysunek 4)
- Podłącz główny kabel (zalecany H05RN-F3G1.0mm2) do przewodu wejściowego naszego produktu przez wodoodporną skrzynkę przyłączeniową. Zwróć uwagę na linię (-) przewodu. (Rysunek 5) (należy użyć skrzynki przyłączeniowej o stopniu ochrony IP65 lub wyższym, dokręcić wodoodporną śrubę) Włącz zasilanie, aby upewnić się, że produkt działa.

INSTRUKCJA DEMONTAŻU

(Tylko dla zespołu nadzoru rynku)

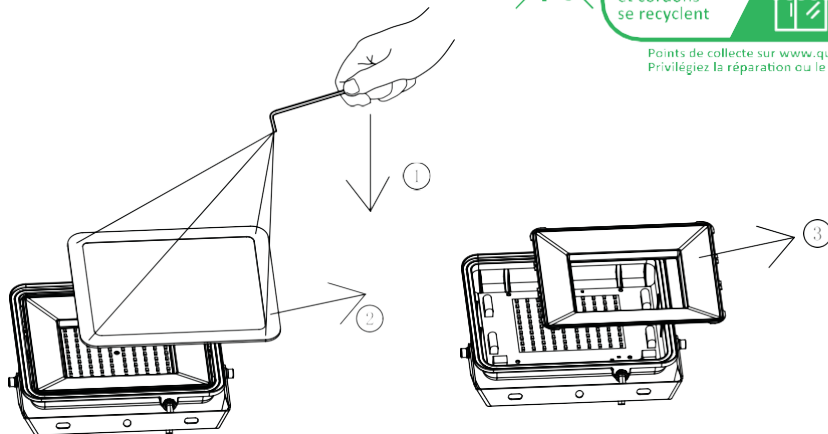

Uwaga: Usunięcie źródła światła spowoduje unieważnienie gwarancji.



Points de collecte sur www.quefairede mesdechets.fr
Privilégiez la réparation ou le don de votre appareil !



W PRZYPADKU JAKICHKOLWIEK PYTAŃ/PROBLEMÓW Z PRODUKTEM, PROSIMY O KONTAKT POD ADRESEM: SUPPORT@V-TAC.EU. A B Y U Z Y S K A Ć WIĘCEJ INFORMACJI, PROSIMY O KONTAKT Z NASZYM DYSTYBUTOREM LUB NAJBLIŻSZYMI DEALERAMI.

V-TAC EUROPE LTD. BULGARIA, PLOVDIV 4000, BULL.KARAVELOW 9B

MANUAL DE INSTRUÇÕES

HOLOFOTE LED



DADOS TÉCNICOS

MODEL	SKU	WATTS	LUMENS	BEAM ANGLE	DF	CRI	INPUT POWER	OPERATION TEMPERATURE	DIMENSION (LxWxH)	N.W. (KGS)	ALTURA MÁXIMA DE MONTAGEM	PROJECTADO ÁREA(mm²)	COMPRIMENTO DO FIO
VT-44010	9898,9899,10010 10011,10012,10013	10W	735LM	115°	>0.9	>70	AC220-240V 50Hz	-20°C to +45°C	104x21x92mm	0.16	<5M	9568	0.15M
VT-44020	10014,10015,10016 10017,10018,10019	20W	1620LM	115°	>0.9	>70	AC220-240V 50Hz	-20°C to +45°C	126,5x28x114mm	0.24	<5M	14421	0.15M
VT-44030	10020,10021,10022 10023,10024,10025	30W	2505LM	115°	>0.9	>70	AC220-240V 50Hz	-20°C to +45°C	164x29x139mm	0.35	<5M	22796	0.15M
VT-44050	10026	50W	4270LM	115°	>0.9	>70	AC220-240V 50Hz	-20°C to +45°C	183x29x169mm	0.48	<5M	30927	0.15M
VT-44100	10348	100W	8700LM	115°	>0.9	>70	AC220-240V 50Hz	-20°C to +45°C	183x29x169mm	0.97	<5M	55118	1M
VT-44200	10027,10028, 10029,10030	200W	17540LM	115°	>0.9	>70	AC220-240V 50Hz	-20°C to +45°C	405x36x326mm	2.29	<5M	132030	1M
VT-44300	10031,10032 10033,10034	300W	26390LM	115°	>0.9	>70	AC220-240V 50Hz	-20°C to +45°C	496x49x445mm	4.28	<5M	220720	1M

*Este produto contém uma fonte de luz da classe de eficiência energética <F>, em que <F> deve ser substituído pela classe de energia da fonte de luz contida.

INTRODUÇÃO E GARANTIA

Obrigado por selecionar e comprar o produto V-TAC. A V-TAC irá servi-lo da melhor forma. Por favor, leia atentamente estas instruções antes de iniciar a instalação e mantenha este manual à mão para referência futura. Se tiver qualquer outra dúvida, contacte o nosso revendedor ou o vendedor local a quem adquiriu o produto. Eles têm formação e estão prontos para o servir da melhor forma. A garantia é válida por 5 anos a partir da data de compra. A garantia não se aplica a danos causados por instalação incorrecta ou desgaste anormal. A empresa não dá qualquer garantia contra danos em qualquer superfície devido à remoção e instalação incorrectas do produto. Os produtos são adequados para um funcionamento diário de 10-12 horas. Utilização do produto para

24 horas por dia anularia a garantia. Este produto tem garantia apenas para defeitos de fabrico.



**IP65
RATING**

**05
YEAR
WARRANTY***

**SAMSUNG
LED
Illuminated**

**PRO
SERIES**

AVISO

- Certifique-se de que desliga a alimentação eléctrica antes de iniciar a instalação.
- A instalação deve ser efectuada por um electricista qualificado.
- A fonte de luz contida nessa luminária só deve ser substituída pelo fabricante, pelo seu agente de assistência ou por uma pessoa qualificada semelhante.
- Se o cabo ou o cordão flexível externo dessa luminária estiver danificado, deve ser substituído exclusivamente pelo fabricante ou pelo seu agente de assistência ou por uma pessoa qualificada semelhante, de modo a evitar qualquer perigo.
- Bloco de terminais não incluído.
- Deve ser assegurada uma ligação à terra adequada durante toda a instalação.
- Para utilização no exterior.
- Substituir qualquer escudo protetor rachado. 
- Distância mínima de objectos iluminados 1m. 



NOTA: Para reduzir o risco de estrangulamento, a cablagem flexível ligada a esta luminária deve ser efetivamente fixada à parede se a cablagem estiver ao alcance do braço.



Esta marcação indica que este produto não deve ser eliminado juntamente com outros resíduos domésticos.



Cuidado, risco de choque eléctrico.

ESQUEMA DE INSTALAÇÃO

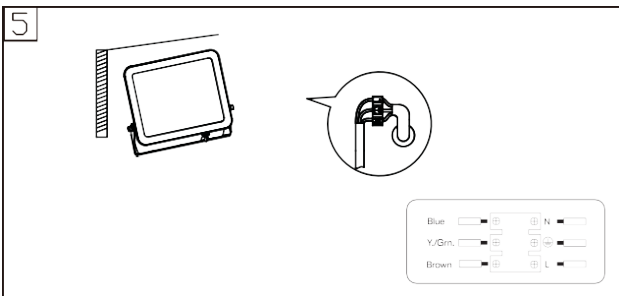
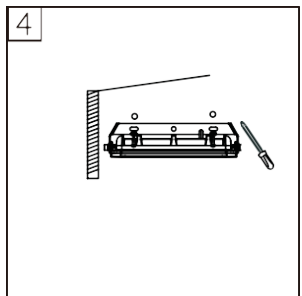
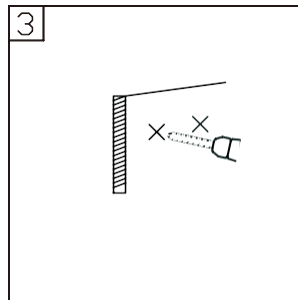
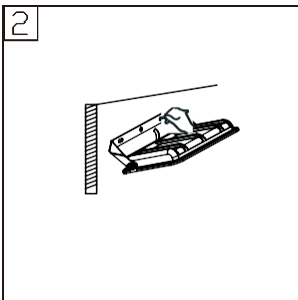
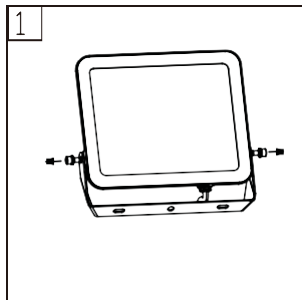

INSTRUÇÕES DE INSTALAÇÃO

- NÃO UTILIZAR EM ÁREAS COM VENTILAÇÃO LIMITADA OU FORA DO INTERVALO DE TEMPERATURA AMBIENTE NOMINAL. *LIGAR APENAS COM UMA CASA DE CABOS À PROVA DE ÁGUA. *CERTIFIQUE-SE DE QUE A ELECTRICIDADE ESTÁ DESLIGADA ANTES DA INSTALAÇÃO.
- Não montar numa superfície propensa a vibrações.
- Em seguida, retire o parafuso e o suporte. (Figura 1) Antes de perfurar, marque a posição do orifício para fixar o suporte na parede (parafuso não fornecido). (Figura 2)
- Aparafusar o suporte de fixação à parede com uma quantidade adequada de parafusos. (Figura 3)
- Montar o suporte de novo no aparelho. Ajuste o projetor de acordo com a posição pretendida. Aperte o parafuso. (Figura 4)
- Ligue o seu cabo principal (H05RN-F3G1.0mm2 Recomendado) com o cabo de entrada do nosso produto através da caixa de junção à prova de água. Note que a linha (-) do cabo. (Figura 5) (É necessário utilizar a caixa de junção de IP65 ou superior, certificar-se de que aperta o parafuso à prova de água) Ligar a alimentação para verificar se o produto está a funcionar.

INSTRUÇÕES DE DESMONTAGEM (Apenas para a equipa de fiscalização do mercado)

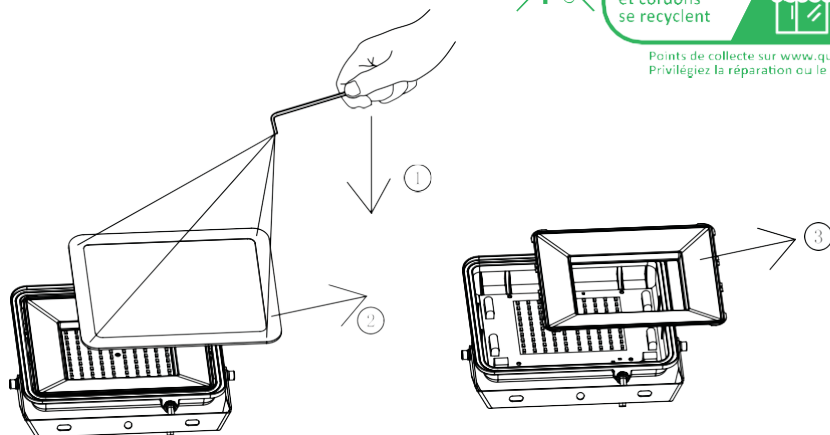

Nota: A remoção da fonte de luz anulará a garantia



Points de collecte sur www.quefairede mesdechets.fr
Privilégiez la réparation ou le don de votre appareil !



EM CASO DE QUALQUER DÚVIDA/PROBLEMA COM O PRODUTO, CONTACTE-NOS ATRAVÉS DE: SUPPORT@V-TAC.EU
PARA MAIS PRODUTOS, CONTACTE O NOSSO DISTRIBUIDOR OU OS REVENDEDORES MAIS PRÓXIMOS.
V-TAC EUROPE LTD. BULGÁRIA, PLOVDIV 4000, BUL.L.KARAVELOW 9B

MANUAL DE INSTRUCȚIUNI A CONDUS LUMINA DE INUNDAȚII



DATE TEHNICE

MODEL	SKU	WATTS	LUMENS	BEAM ANGLE	DF	CRI	INPUT POWER	OPERATION TEMPERATURE	DIMENSION (LxWxH)	N.W. (KGS)	ÎNĂLȚIMEA MAXIMĂ DE MONTARE	PROIECTAT ZONA(mm²)	LUNGI MEA FIRULUI
VT-44010	9898,9899,10010 10011,10012,10013	10W	735LM	115°	>0.9	>70	AC220-240V 50Hz	-20°C to +45°C	104x21x92mm	0.16	<5M	9568	0.15M
VT-44020	10014,10015,10016 10017,10018,10019	20W	1620LM	115°	>0.9	>70	AC220-240V 50Hz	-20°C to +45°C	126.5x28x114mm	0.24	<5M	14421	0.15M
VT-44030	10020,10021,10022 10023,10024,10025	30W	2505LM	115°	>0.9	>70	AC220-240V 50Hz	-20°C to +45°C	164x29x139mm	0.35	<5M	22796	0.15M
VT-44050	10026	50W	4270LM	115°	>0.9	>70	AC220-240V 50Hz	-20°C to +45°C	183x29x169mm	0.48	<5M	30927	0.15M
VT-44100	10348	100W	8700LM	115°	>0.9	>70	AC220-240V 50Hz	-20°C to +45°C	183x29x169mm	0.97	<5M	55118	1M
VT-44200	10027,10028, 10029,10030	200W	17540LM	115°	>0.9	>70	AC220-240V 50Hz	-20°C to +45°C	405x36x326mm	2.29	<5M	132030	1M
VT-44300	10031,10032 10033,10034	300W	26390LM	115°	>0.9	>70	AC220-240V 50Hz	-20°C to +45°C	496x49x445mm	4.28	<5M	220720	1M

*Acest produs conține o sursă de lumină cu clasa de eficiență energetică <F>, unde <F> este înlocuit cu clasa energetică a sursei de lumină conținute.

INTRODUCERE ȘI GARANȚIE

Vă mulțumim pentru selectarea și cumpărarea produsului V-TAC. V-TAC vă va servi cel mai bine. Vă rugăm să citiți cu atenție aceste instrucțiuni înainte de a începe instalarea și să păstrați acest manual la îndemână pentru consultare ulterioară. Dacă aveți orice altă întrebare, vă rugăm să contactați distribuitorul nostru sau vânzătorul local de la care ați achiziționat produsul. Aceștia sunt instruiți și pregătiți să vă servească la cel mai bun nivel. Garanția este valabilă timp de 5 ani de la data achiziției. Garanția nu se aplică daunelor cauzate de instalarea incorectă sau de uzura anormală. Compania nu oferă nicio garanție împotriva deteriorării oricărei suprafețe din cauza îndepărtării și instalării incorecte a produsului. Produsele sunt potrivite pentru o funcționare zilnică de 10-12 ore. Utilizare a produsului pentru 24 de ore pe zi ar anula garanția. Acest produs este garantat numai pentru defectele de fabricație.

**IP65
RATING**

**05
YEAR
WARRANTY***

**SAMSUNG
LED
Illuminated**

**PRO
SERIES**

AVERTISMENT

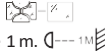
- Vă rugăm să vă asigurați că opriți alimentarea înainte de a începe instalarea.
- Instalarea trebuie să fie efectuată de un electrician calificat.
- Sursa de lumină conținută în acest corp de iluminat poate fi înlocuită numai de către producător sau de către agentul său de service sau de către o persoană calificată similară.
- În cazul în care cablul sau cablul flexibil extern al acestui corp de iluminat este deteriorat, acesta trebuie înlocuit exclusiv de producător sau de agentul său de service sau de o persoană calificată similară, pentru a evita un pericol.
- Blocul terminal nu este inclus.
- Trebuie asigurată o împănântare corespunzătoare pe întreaga durată a instalației.
- Pentru utilizare în exterior.
- Înlocuiți orice scut de protecție crăpat.
- Distanța minimă față de obiectele luminate este de 1 m. 

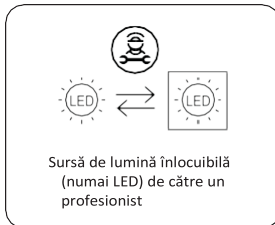

NOTĂ: Pentru a reduce riscul de strangulare, cablurile flexibile conectate la acest corp de iluminat trebuie să fie fixate efectiv pe perete dacă cablurile sunt la îndemâna utilizatorului.



Acest marcaj indică faptul că acest produs nu trebuie eliminat împreună cu alte deșeuri menajere.



Atenție, risc de electrocutare.

DIAGRAMA DE INSTALARE

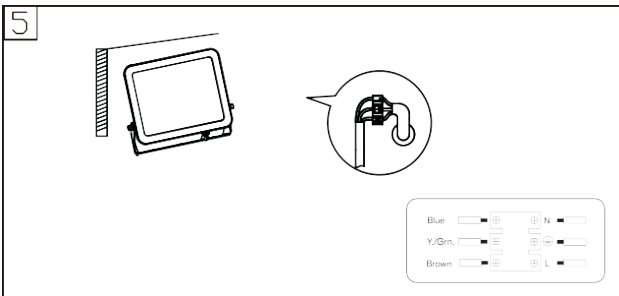
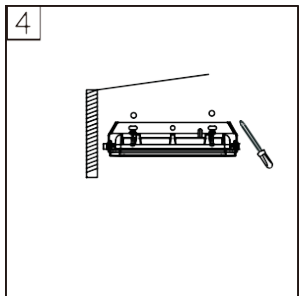
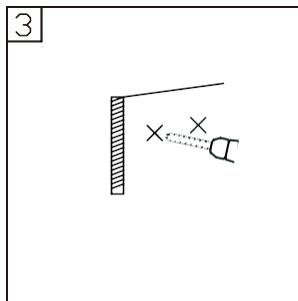
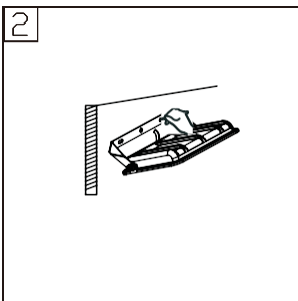
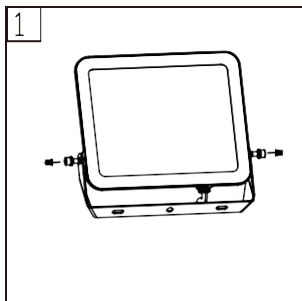

INSTRUCȚIUNI DE INSTALARE

- NU UTILIZAȚI ÎN ZONE CU VENTILAȚIE LIMITATĂ SAU ÎN AFARA INTERVALULUI DE TEMPERATURĂ AMBIENTALĂ NOMINALĂ. *CONECTAȚI NUMAI CU O CASĂ DE CABLURI IMPERMEABILĂ. *ASIGURAȚI-VĂ CĂ ELECTRICITATEA ESTE OPRITĂ ÎNAINTE DE INSTALARE.
- Vă rugăm să nu montați pe o suprafață care este predispusă la vibrații.*
- Îndepărtați șurubul și suportul după aceea. (Figura 1)Înainte de găurire, marcați poziția găurii pentru fixarea suportului pe perete (șurubul nu este furnizat). (Figura 2)
- Înșurubați suportul de fixare la perete cu o cantitate adecvată de șuruburi. (Figura 3)
- Montați suportul înapoi pe instalație. Reglați proiectorul în funcție de poziția dorită. Strângeți șurubul. (Figura 4) Conectați cablul principal (recomandat H05RN-F3G1.0mm2) cu cablul de intrare al produsului nostru prin cutia de joncțiune impermeabilă. Rețineți, linia (-) a cablului. (Figura 5) (Trebuie să utilizați cutia de joncțiune IP65 sau mai mare, asigurați-vă că strângeți șurubul impermeabil) Porniți alimentarea pentru a vă asigura că produsul funcționează.

INSTRUCȚIUNI DE DEMONTARE

(Numai pentru echipa de supraveghere a pieței)

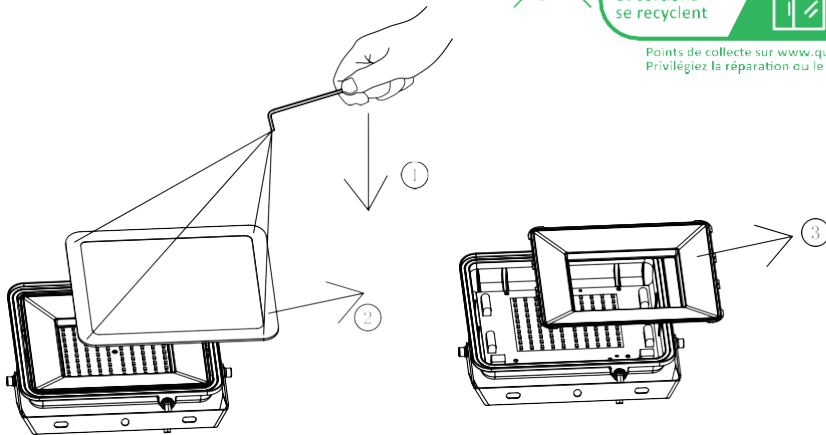

Notă: Îndepărtarea sursei de lumină va anula garanția



RoHS



UK
CA



ÎN CAZUL ORICĂREI ÎNTREBĂRI/PROBLEME LEGATE DE PRODUS, VĂ RUGĂM SĂ NE CONTACTAȚI LA: SUPPORT@V-TAC.EU PENTRU O GAMĂ MAI LARGĂ DE PRODUSE, VĂ RUGĂM SĂ CONTACTAȚI DISTRIBUITORUL NOSTRU SAU CEI MAI APROPIAȚI DEALERI.

V-TAC EUROPE LTD. BULGARIA, PLOVDIV 4000, BUL.L.KARAELOW 9B

MANUAL DE INSTRUCCIONES

PROYECTOR LED



DATOS TÉCNICOS

MODEL	SKU	WATTS	LUMENS	BEAM ANGLE	DF	CRI	INPUT POWER	OPERATION TEMPERATURE	DIMENSION (LxWxH)	N.O. (KGS)	ALTURA MÁXIMA DE MONTAJE	PROYECTO ÁREA(mm²)	LONGITUD DEL CABLE
VT-44010	9898,9899,10010 10011,10012,10013	10W	735LM	115°	>0.9	>70	AC220-240V 50Hz	-20°C to +45°C	104x21x92mm	0.16	<5M	9568	0.15M
VT-44020	10014,10015,10016 10017,10018,10019	20W	1620LM	115°	>0.9	>70	AC220-240V 50Hz	-20°C to +45°C	126,5x28x114mm	0.24	<5M	14421	0.15M
VT-44030	10020,10021,10022 10023,10024,10025	30W	2505LM	115°	>0.9	>70	AC220-240V 50Hz	-20°C to +45°C	164x29x139mm	0.35	<5M	22796	0.15M
VT-44050	10026	50W	4270LM	115°	>0.9	>70	AC220-240V 50Hz	-20°C to +45°C	183x29x169mm	0.48	<5M	30927	0.15M
VT-44100	10348	100W	8700LM	115°	>0.9	>70	AC220-240V 50Hz	-20°C to +45°C	183x29x169mm	0.97	<5M	55118	1M
VT-44200	10027,10028, 10029,10030	200W	17540LM	115°	>0.9	>70	AC220-240V 50Hz	-20°C to +45°C	405x36x326mm	2.29	<5M	132030	1M
VT-44300	10031,10032 10033,10034	300W	26390LM	115°	>0.9	>70	AC220-240V 50Hz	-20°C to +45°C	496x49x445mm	4.28	<5M	220720	1M

*Este producto contiene una fuente luminosa de clase de eficiencia energética <F>, donde <F> se sustituirá por la clase de energía de la fuente luminosa contenida.

INTRODUCCIÓN Y GARANTÍA

Gracias por seleccionar y comprar un producto V-TAC. V-TAC le servirá lo mejor posible. Lea atentamente estas instrucciones antes de iniciar la instalación y conserve este manual a mano para futuras consultas. Si tiene cualquier otra duda, póngase en contacto con nuestro distribuidor o vendedor local al que haya comprado el producto. Están formados y preparados para atenderle lo mejor posible. La garantía es válida durante 5 años a partir de la fecha de compra. La garantía no se aplica a los daños causados por una instalación incorrecta o un desgaste anormal. La empresa no ofrece ninguna garantía contra daños en cualquier superficie debidos a una incorrecta retirada e instalación del producto. Los productos son adecuados para un funcionamiento de 10-12 horas diarias. Uso del producto para 24 horas al día anularía la garantía. Este producto está garantizado por defectos de fabricación solamente.



**IP65
RATING**

**05
YEAR
WARRANTY***

**SAMSUNG
LED
Illuminated**

**PRO
SERIES**

ADVERTENCIA

- Asegúrese de desconectar la alimentación antes de iniciar la instalación.
- La instalación debe ser realizada por un electricista cualificado.
- La fuente luminosa contenida en esta luminaria sólo podrá ser sustituida por el fabricante o su agente de servicio o una persona cualificada similar.
- Si el cable o cordón flexible externo de esta luminaria está dañado, deberá ser sustituido exclusivamente por el fabricante o su agente de servicio o una persona cualificada similar para evitar riesgos.
- Bloque de terminales no incluido.
- Debe garantizarse una conexión a tierra adecuada en toda la instalación.
- Para uso exterior.
- Sustituya cualquier pantalla protectora agrietada. 
- Distancia mínima a objetos iluminados 1m. 



NOTA: Para reducir el riesgo de estrangulamiento, el cableado flexible conectado a esta luminaria deberá fijarse eficazmente a la pared si el cableado está al alcance de la mano.



Esta marca indica que este producto no debe eliminarse con otros residuos domésticos.



Precaución, riesgo de descarga eléctrica.

DIAGRAMA DE INSTALACIÓN

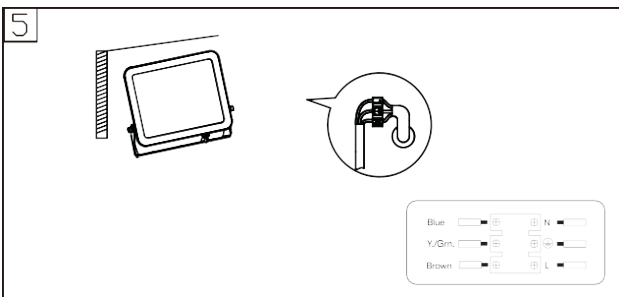
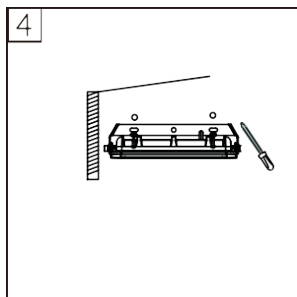
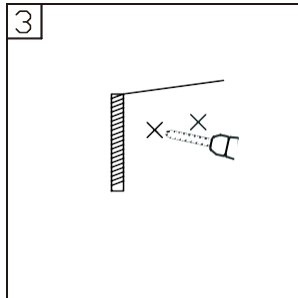
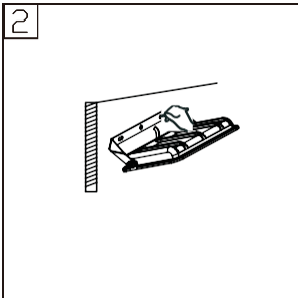
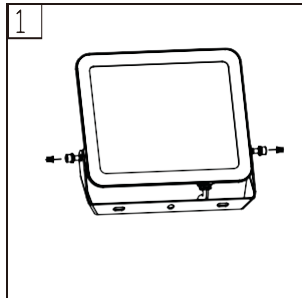

INSTRUCCIONES DE INSTALACIÓN

- NO UTILIZAR EN ZONAS CON VENTILACIÓN LIMITADA O FUERA DEL RANGO DE TEMPERATURA AMBIENTE NOMINAL. *CONECTE SÓLO CON UNA CAJA DE CABLES IMPERMEABLE. *ASEGÚRESE DE QUE LA ELECTRICIDAD ESTÉ DESCONECTADA ANTES DE LA INSTALACIÓN.
- No lo monte en una superficie expuesta a vibraciones.
- A continuación, retire el tornillo y el soporte. (Figura 1) Antes de taladrar, marque la posición del orificio para fijar el soporte a la pared (tornillo no suministrado). (Figura 2)
- Atornille el soporte de sujeción a la pared con una cantidad adecuada de tornillos. (Figura 3)
- Vuelva a montar el soporte en la luminaria. Ajuste el proyector según la posición deseada. Apriete el tornillo. (Figura 4)
- Conecte su cable principal (Recomendado H05RN-F3G1.0mm2) con el cable de entrada de nuestro producto a través de la caja de conexiones impermeable. Tenga en cuenta la línea (-) del cable. (Figura 5) (Para utilizar la caja de conexiones IP65 o superior, asegúrese de apretar el tornillo impermeable) Conecte la alimentación para asegurarse de que el producto funciona.

INSTRUCCIONES DE DESMONTAJE

(Sólo para el equipo de vigilancia del mercado)

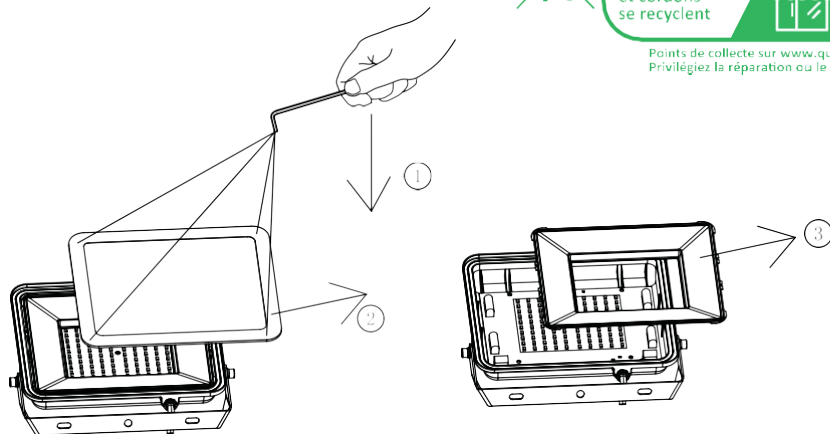

Nota: La eliminación de la fuente de luz anulará la garantía.



EN CASO DE CUALQUIER DUDA O PROBLEMA CON EL PRODUCTO, PÓNGASE EN CONTACTO CON NOSOTROS EN:
SUPPORT@V-TAC.EU PARA MÁS GAMA DE PRODUCTOS, CONSULTA POR FAVOR PÓNGASE EN CONTACTO CON
NUESTRO DISTRIBUIDOR O DISTRIBUIDORES MÁS CERCANOS.
V-TAC EUROPE LTD. BULGARIA, PLOVDIV 4000, BUL.L.KARAVELOW 9B